

DATE
JAN. 4, 2007
CAT. #: EPV0304C

OUTLINE DIMENSIONS
3-PHASE INDUCTION MOTOR

MOTOR TYPE:
AEUH8NDC
FRAME NO. 286TC

Pole	HP	kW	Hz	VOLT	Syn. Speed r/min(rpm)
4	30	22	60	230/460	1800

Ins	Rating	Dimension in	Approx Weight	Bearings
F	CONT.	inches	495 LBS	DE: 6311ZZ NDE: 6310ZZ

Totally Enclosed Fan-Cooled Vertical Type, Squirrel-cage Rotor.

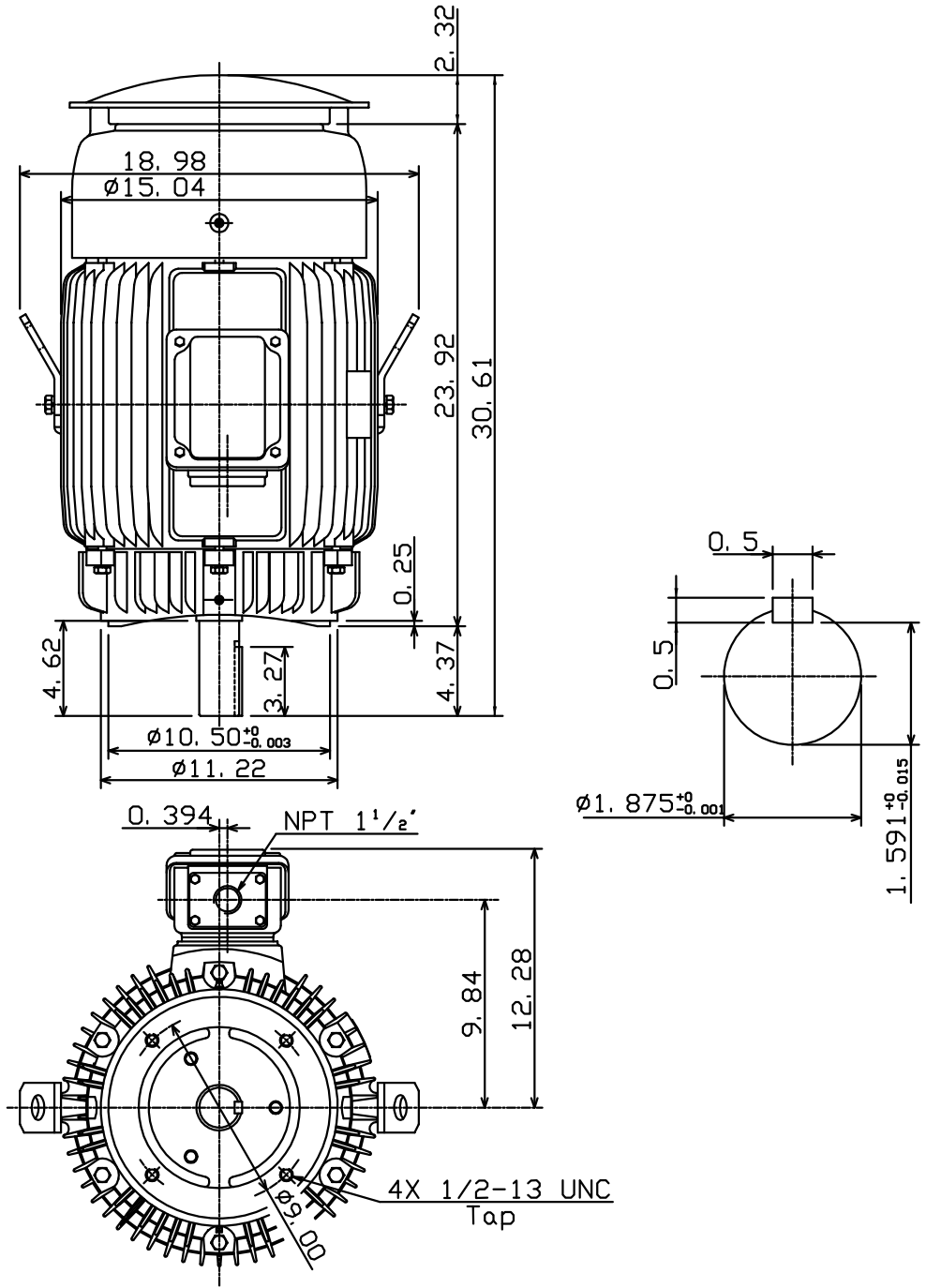

DWN. K. L. KUO 12-30-06
CHKD. K. L. KUO 01-02-07
APPD. M. C. TSAI 01-02-07



DWG NO.
31057H316310