

DATE
Sept. 25, 2006
Cat. #: EP7/52C-50

OUTLINE DIMENSIONS

3-PHASE INDUCTION MOTOR

MOTOR TYPE:
AEHH8N-CF
FRAME NO. 213TC

Pole	HP	kW	Hz	VOLT	Syn. Speed r/min(rpm)
2	7.5	5.6	50	190/380	3000

Ins	Rating	Dimension in	Approx Weight	Bearings
F	CONT.	inches	175	DE: 6308ZZ NDE: 6306ZZ

Totally Enclosed Fan-Cooled Type. Squirrel-Cage Rotor.

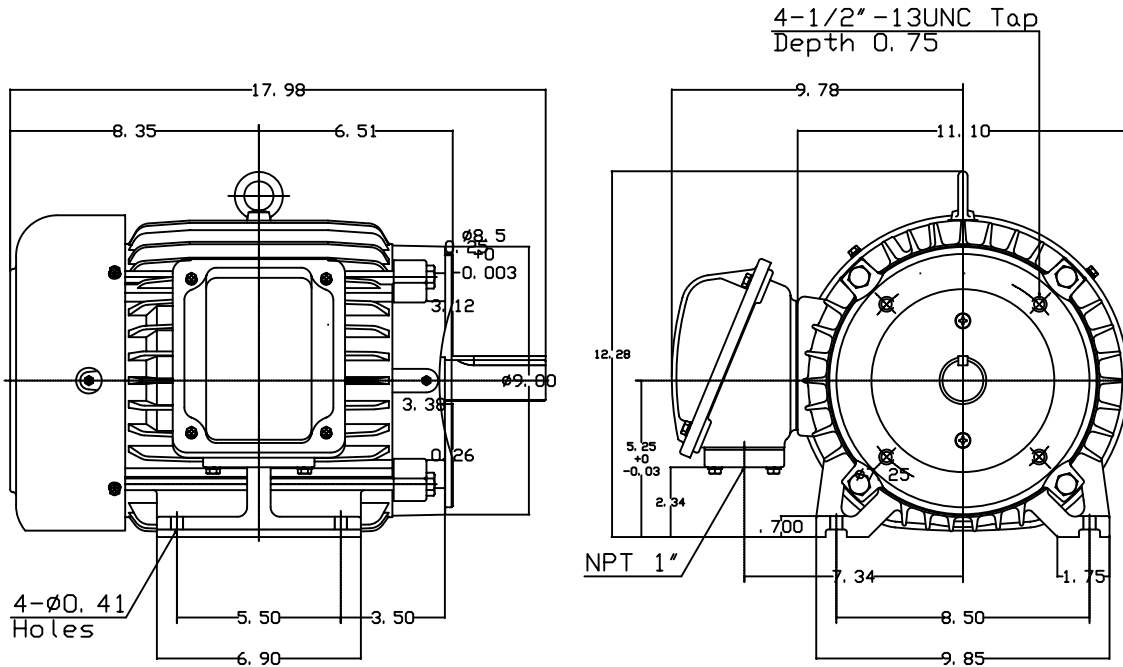

DWN.	F. C. HWU	07-22-97
CHKD.	C. S. LO	07-23-97
APPD.	Y. B. HUANG	07-23-97



DWG NO.
31049J809060