

TYPE	OUTPUT		POLE	TIME RATING	VOLTAGE V	Hz	SYN.SPEED R.P.M
	HP.	KW.					
AEHH8N	400	298	6	CONT.	460	60	1200

TOTALLY ENCLOSED FAN-COOLED TYPE, SQUIRREL-CAGE ROTOR

PRIMARY T-BOX
(NPT4")

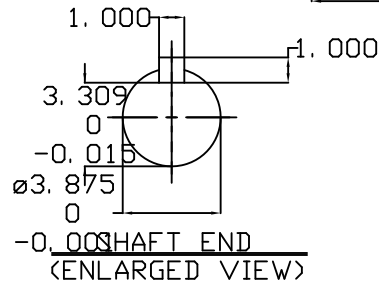
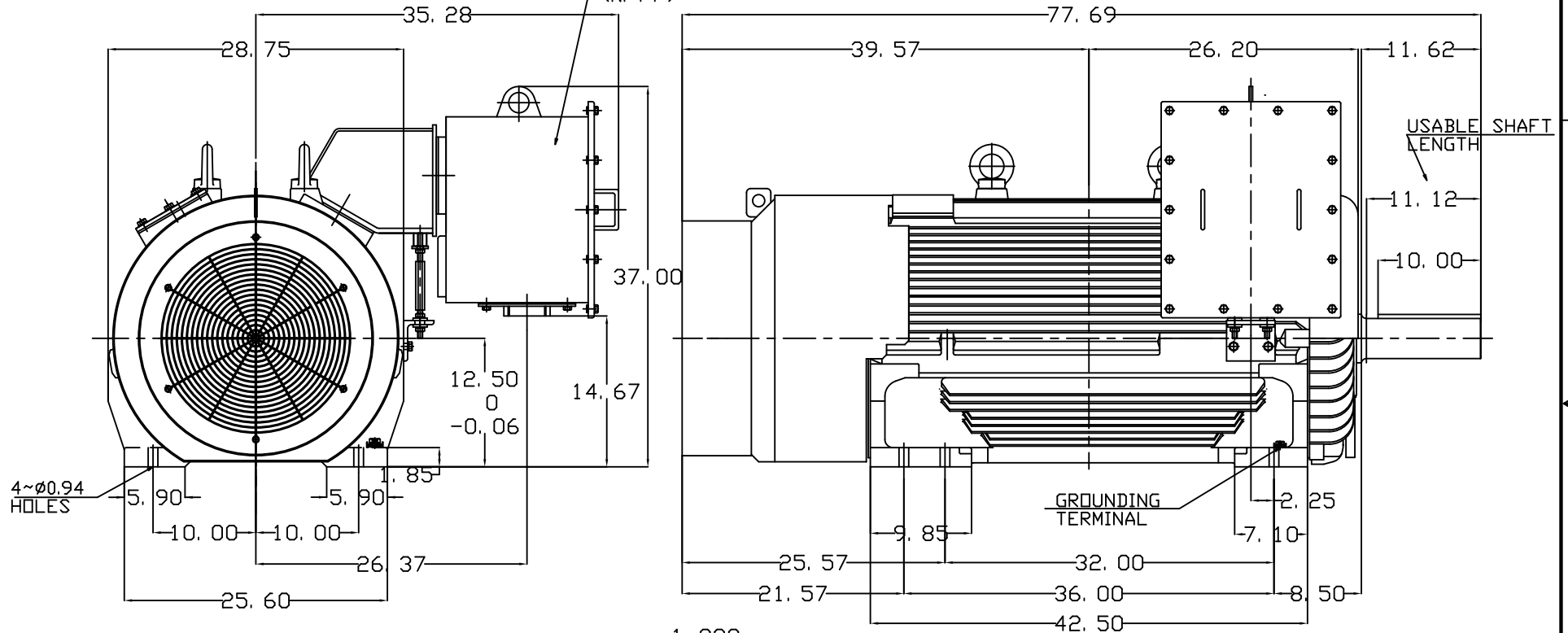

NOTE:

- DIMENSIONS IN inch
- FRAME NO. 5011B(5010B)
- F CLASS INSULATION, S.F.1.15
- FOR DIRECT FLEXIBLE COUPLING
- ENCLOSURE: IP55
- BEARING SIZE: DRIVE-END 6324
OPP. DRIVE-END 6320
- MOTOR APPROX. WEIGHT: 4900 lb

DATE	OUTLINE DIMENSIONS	
CATALOG # EP4006	3-PHASE INDUCTION MOTOR	
DWN. Y.DU MAR-20-2014	TECO Westinghouse	DWG NO. REV:00
CHKD. W.CHENG MAR-29-2014		4B040C015
APPD. C.SHIH MAR-29-2014		