

TYPE	OUTPUT		POLE	TIME RATING	VOLTAGE	Hz	SYN.SPEED R.P.M
	HP.	KW.					
AEH8N	200	149.2	6		460	60	1200

TOTALLY ENCLOSED FAN-COOLED TYPE, SQUIRREL-CAGE ROTOR

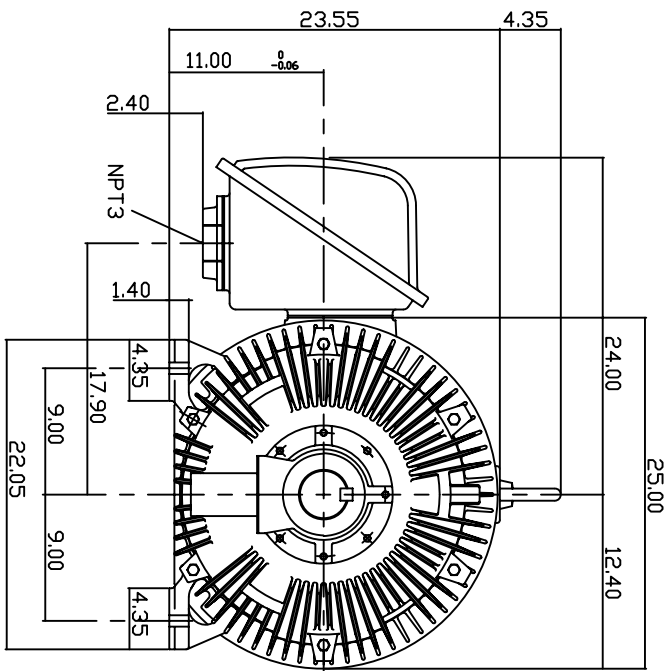
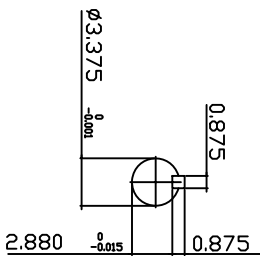
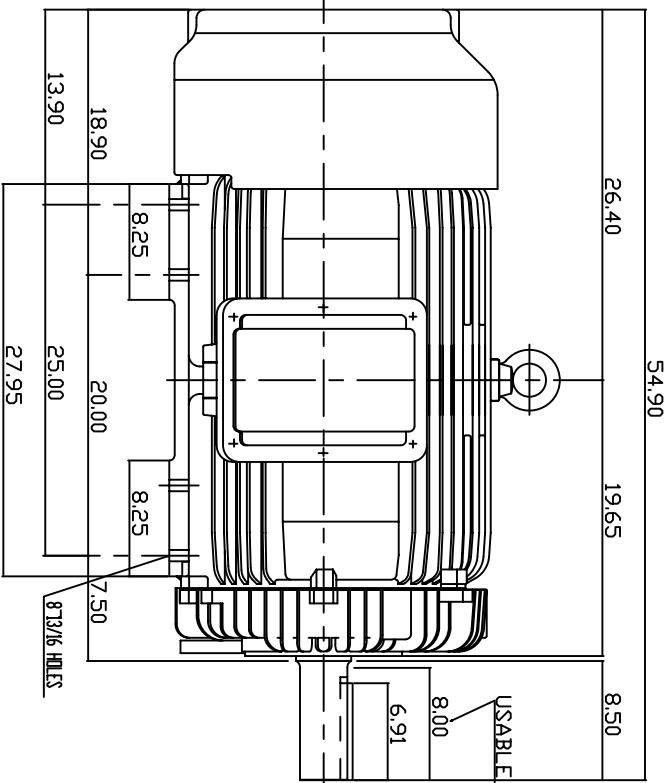

NOTE:

1. DIMENSIONS IN INCH
2. FRAME NO. 449T
3. F CLASS INSULATION, S.F.115
4. FOR DIRECT FLEXIBLE COUPLING
5. ENCLOSURE: IP54
6. BEARING SIZE: DRIVE END: 6320
NON-DRIVE END: 6316
7. APPROX. WEIGHT: 3450 LBS

TW-56C

DWN.	J.WANG	JAN -28 -2005
CHKD.	H.HUANG	JAN -28 -2005
APPD.	C.WANG	JAN -28 -2005

DATE 20050616
CATALOG # EP2006

OUTLINE DIMENSIONS
3-PHASE INDUCTION MOTOR



DWG NO. 3A040Y647
REV: 00