

TYPE	OUTPUT		POLE	TIME RATING	VOLTAGE V	Hz	SYN.SPEED R.P.M
	HP.	KW.					
AEHH8NCF	125	93.3	6	CONT.	460	60	1200

TOTALLY ENCLOSED FAN-COOLED TYPE. SQUIRREL-CAGE ROTOR

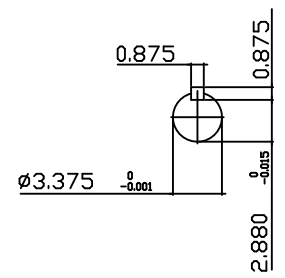
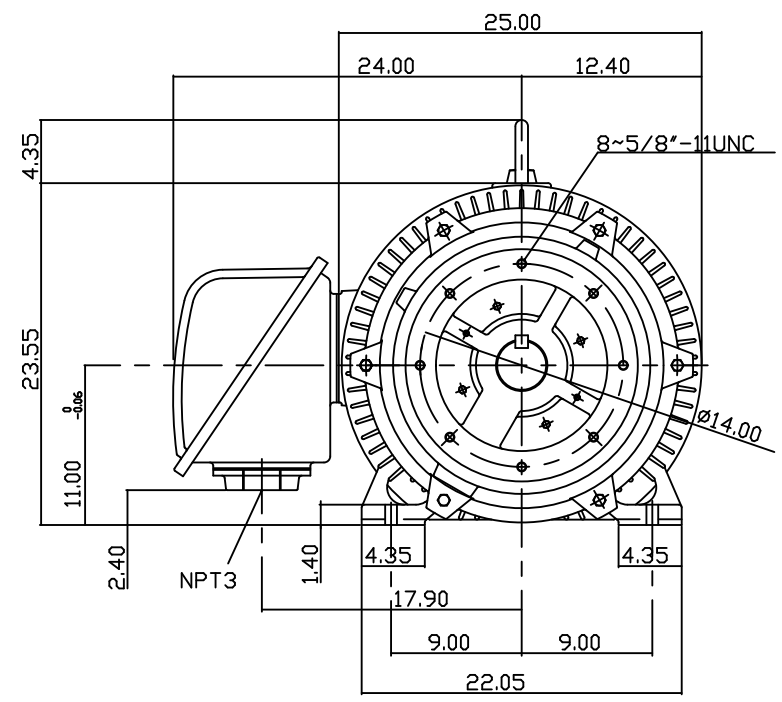
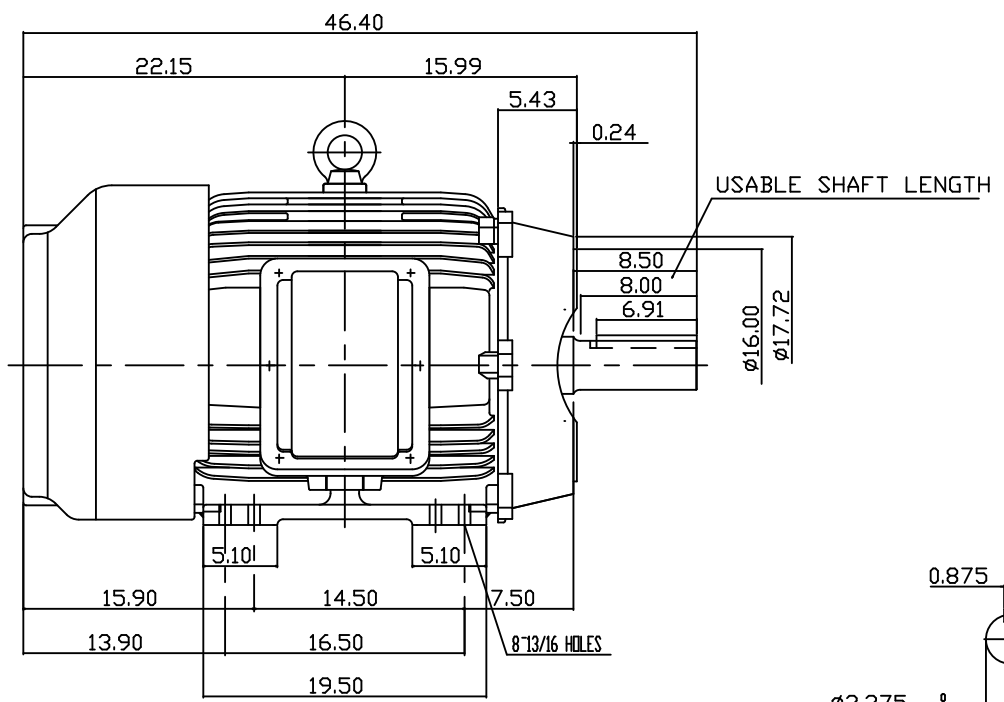

- NOTE:
1. DIMENSIONS IN INCH
 2. FRAME NO. 445TC
 3. F CLASS INSULATION, S.F.115
 4. FOR DIRECT FLEXIBLE COUPLING
 5. ENCLOSURE: IP54
 6. BEARING SIZE: DRIVE END: 6318
NON-DRIVE END: 6316
 7. APPROX. WEIGHT: 1900 LBS

TW-56C

DATE	July, 31, 2013	OUTLINE DIMENSIONS
Catalog #	EP1256C	3-PHASE INDUCTION MOTOR
DWN. Y.ZHU	JAN '04 2006	TEC Westinghouse
CHKD. H.HUANG	JAN '04 2006	
APPD. C.WANG	JAN '04 2006	
		DWG NO. REV: 00
		3B040C729