

DATE
Sept. 8, 2005
CAT. #: EP1004R-50

OUTLINE DIMENSIONS
3-PHASE INDUCTION MOTOR

MOTOR TYPE:
AEHH8N
FRAME NO. 405T

Pole	HP	kW	Hz	VOLT	Syn. Speed r/min(rpm)
4	100	75	50	190/380	1500

Ins	Rating	Dimension in	Approx Weight	Bearings
F	CONT.	inches	1303 lbs.	DE: NU317 NDE: 6313

Totally Enclosed Fan Cooled Type, Squirrel-cage Rotor.

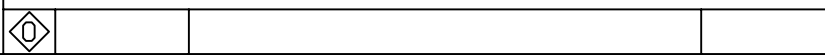
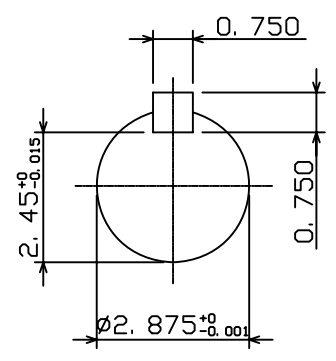
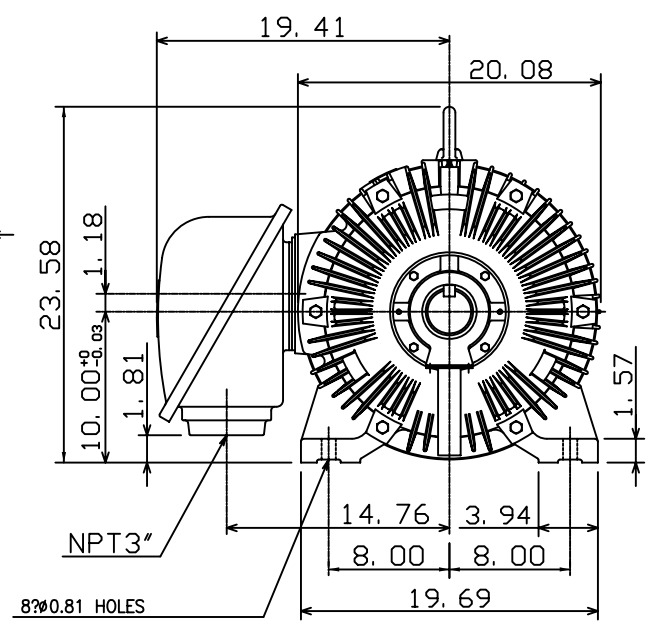
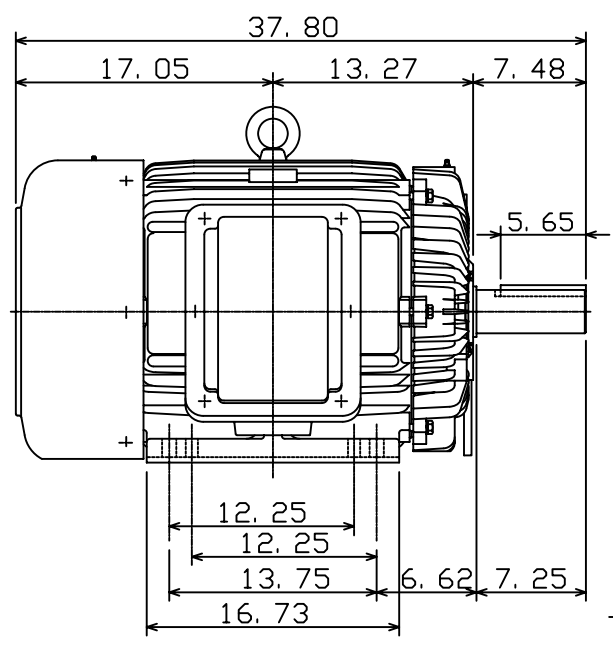

DWN.	K. L. KUO	01-11-05
CHKD.	C. H. KAO	01-28-05
APPD.	M. C. TSAI	01-28-05



DWG NO.
31057H373470