

DATE
Sept. 8, 2005
CAT. #: EP0756

OUTLINE DIMENSIONS
3-PHASE INDUCTION MOTOR

MOTOR TYPE:
AEHH8N
FRAME NO. 405T

Pole	HP	kW	Hz	VOLT	Syn. Speed r/min(rpm)
6	75	56	60	230/460	1200

Ins	Rating	Dimension in	Approx Weight	Bearings	
F	CONT.	inches	1270 lbs.	DE: 6317	NDE: 6313

Totally Enclosed Fan Cooled Type, Squirrel-cage Rotor.

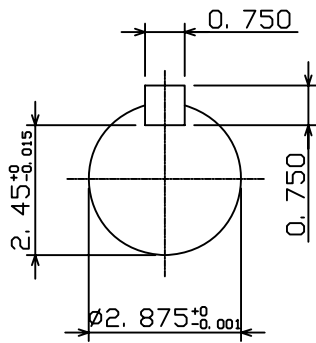
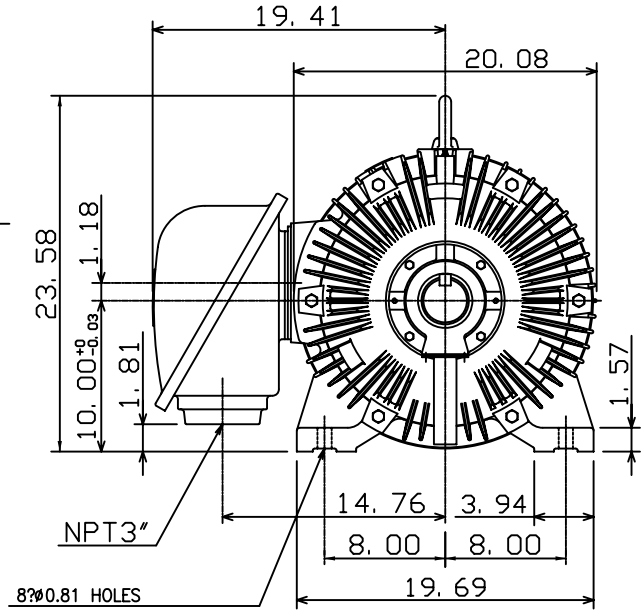
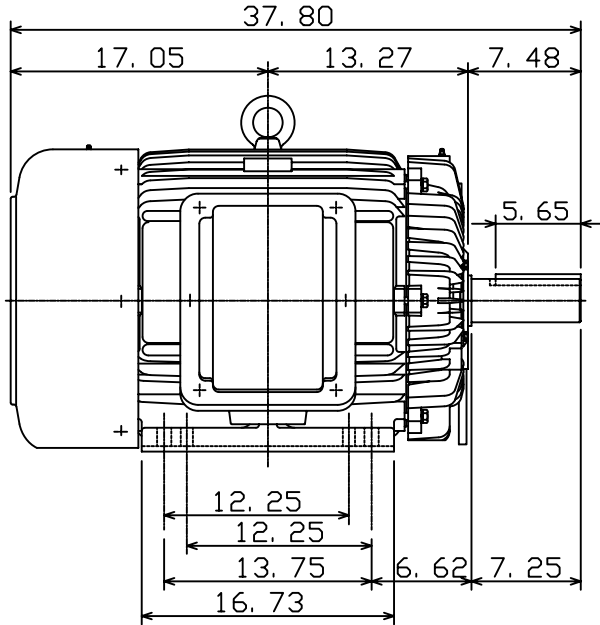

□		
---	--	--

DWN.	K. L. KUO	01-11-05
CHKD.	C. H. KAO	01-28-05
APPD.	M. C. TSAI	01-28-05



DWG NO.
31057H373470