

DATE  
Sept. 8, 2005  
CAT. #: EPO5045

OUTLINE DIMENSIONS  
3-PHASE INDUCTION MOTOR

MOTOR TYPE:  
AEHH8N  
FRAME NO. 326T

Pole	HP	kW	Hz	VOLT	Syn. Speed r/min(rpm)
4	50	37.3	60	575	1800

Ins	Rating	Dimension in	Approx Weight	Bearings	
F	CONT.	inches	739 lbs.	DE: 6312	NDE: 6212

Totally Enclosed Fan-Cooled Type. Squirrel-Cage Rotor.

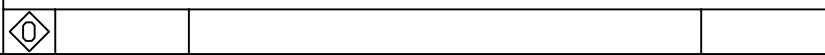
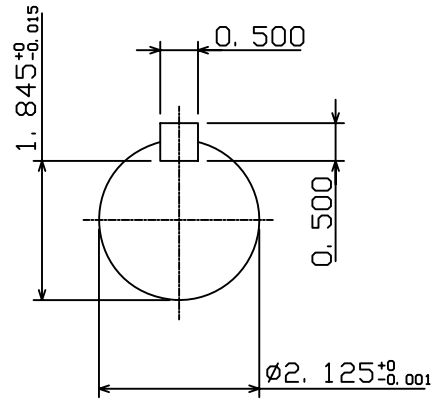
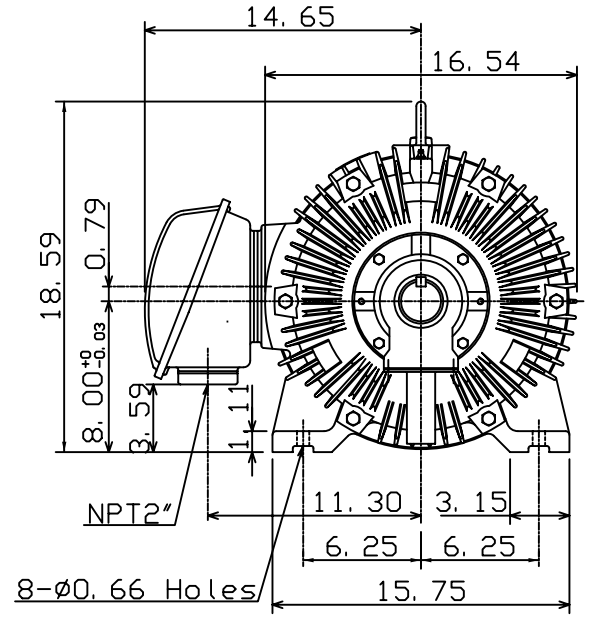
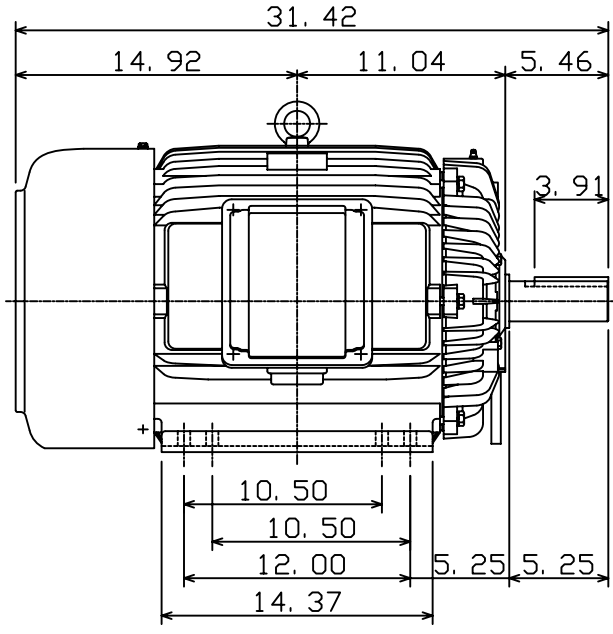

DWN.	K. L. KUD	01-10-05
CHKD.	C. H. KAD	01-28-05
APPD.	M. C. TSAI	01-28-05



DWG NO.  
31057H366320