

DATE  
Sept. 25, 2006  
Cat. #: EPO406C

OUTLINE DIMENSIONS  
3-PHASE INDUCTION MOTOR

MOTOR TYPE:  
AEHH8N-CF  
FRAME NO. 364TC

Pole	HP	kW	Hz	VOLT	Syn. Speed r/min(rpm)
6	40	30	60	230/460	1200

Ins	Rating	Dimension in	Approx Weight	Bearings	
F	CONT.	inches	920 lbs	DE: 6313	NDE: 6213

Totally Enclosed Fan Cooled Type. Squirrel-cage Rotor.

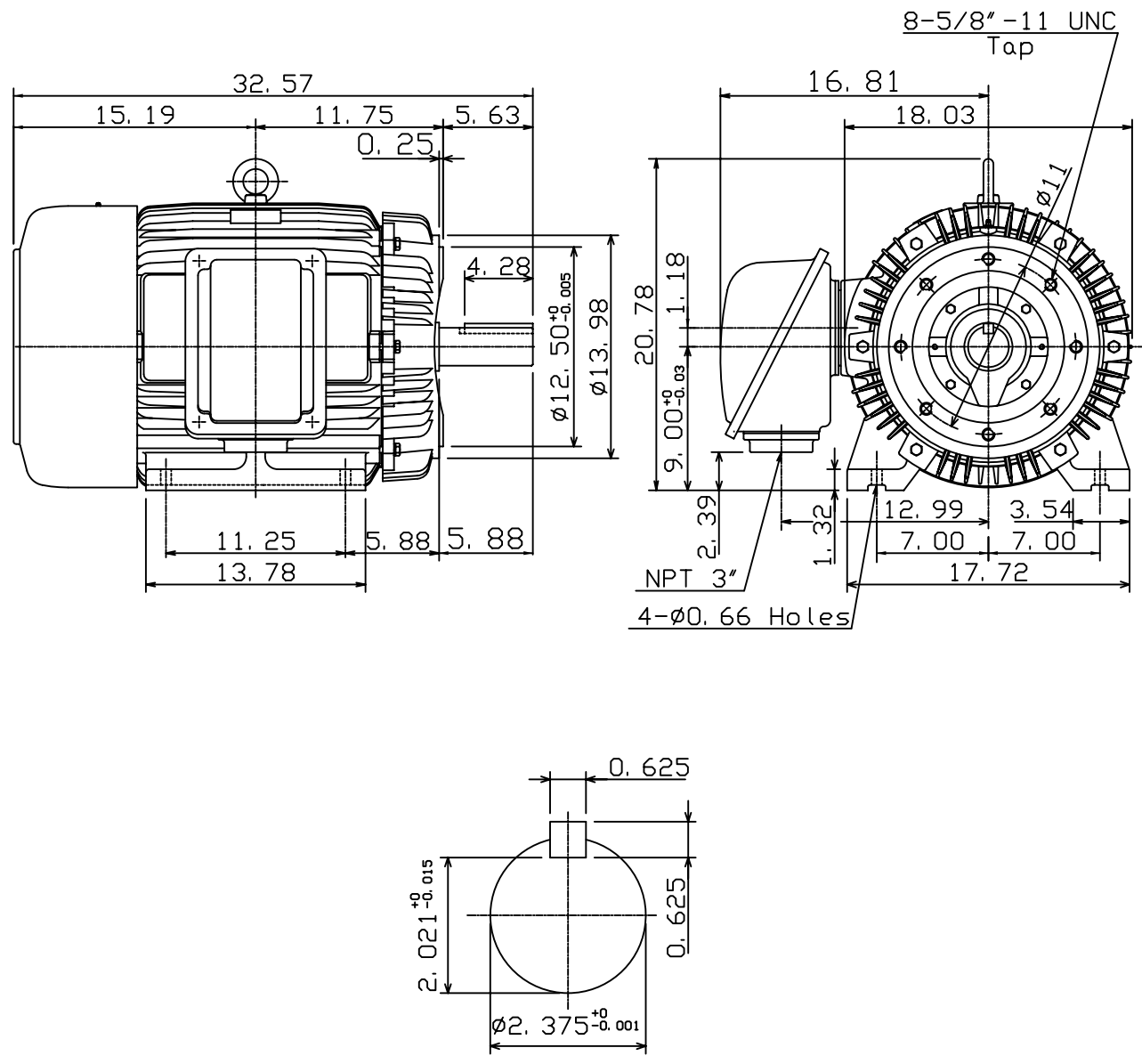

① 01. 11. 05 K. L. KUO

DWN.	W. C. LAY	07-21-97
CHKD.	C. H. KAO	07-21-97
APPD.	Y. B. HUANG	07-21-97



DWG NO.  
31049J717101