

DATE
Sept. 25, 2006
Cat. #: EP0404C-50

OUTLINE DIMENSIONS
3-PHASE INDUCTION MOTOR

MOTOR TYPE:
AEHH8N-CF
FRAME NO. 324TC

Pole	HP	kW	Hz	VOLT	Syn. Speed r/min(rpm)
4	40	30	50	190/380	1500

Ins	Rating	Dimension in	Approx Weight	Bearings	
F	CONT.	inches	682 lbs	DE: 6312	NDE: 6212

Totally Enclosed Fan Cooled Type. Squirrel-cage Rotor.

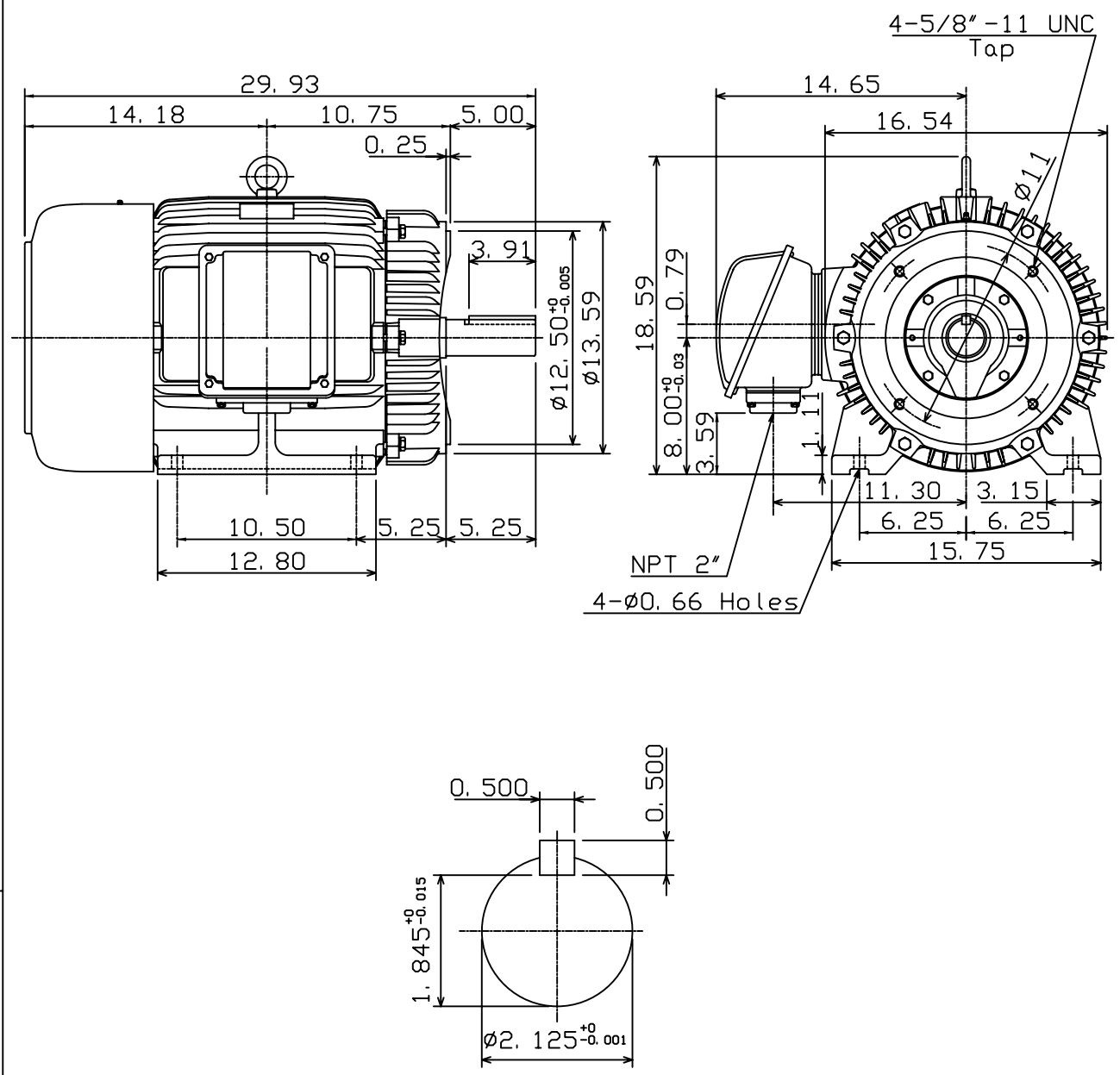

① 01. 10. 05 K. L. KUO

DWN.	W. C. LAY	07-21-97
CHKD.	C. H. KAO	07-21-97
APPD.	Y. B. HUANG	07-21-97



DWG NO.
31049J677101