

DATE
Sept. 25, 2006
Cat. #: EP0202C-50

OUTLINE DIMENSIONS
3-PHASE INDUCTION MOTOR

MOTOR TYPE:
AEHH8N-CF
FRAME NO. 256TC

Pole	HP	kW	Hz	VOLT	Syn. Speed r/min(rpm)
2	20	15	50	190/380	3000

Ins	Rating	Dimension in	Approx Weight	Bearings
F	CONT.	inches	350 lbs	DE: 6309ZZ NDE: 6307ZZ

Totally Enclosed Fan Cooled Type. Squirrel-cage Rotor.

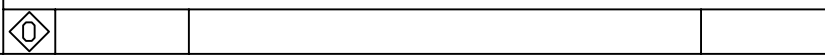
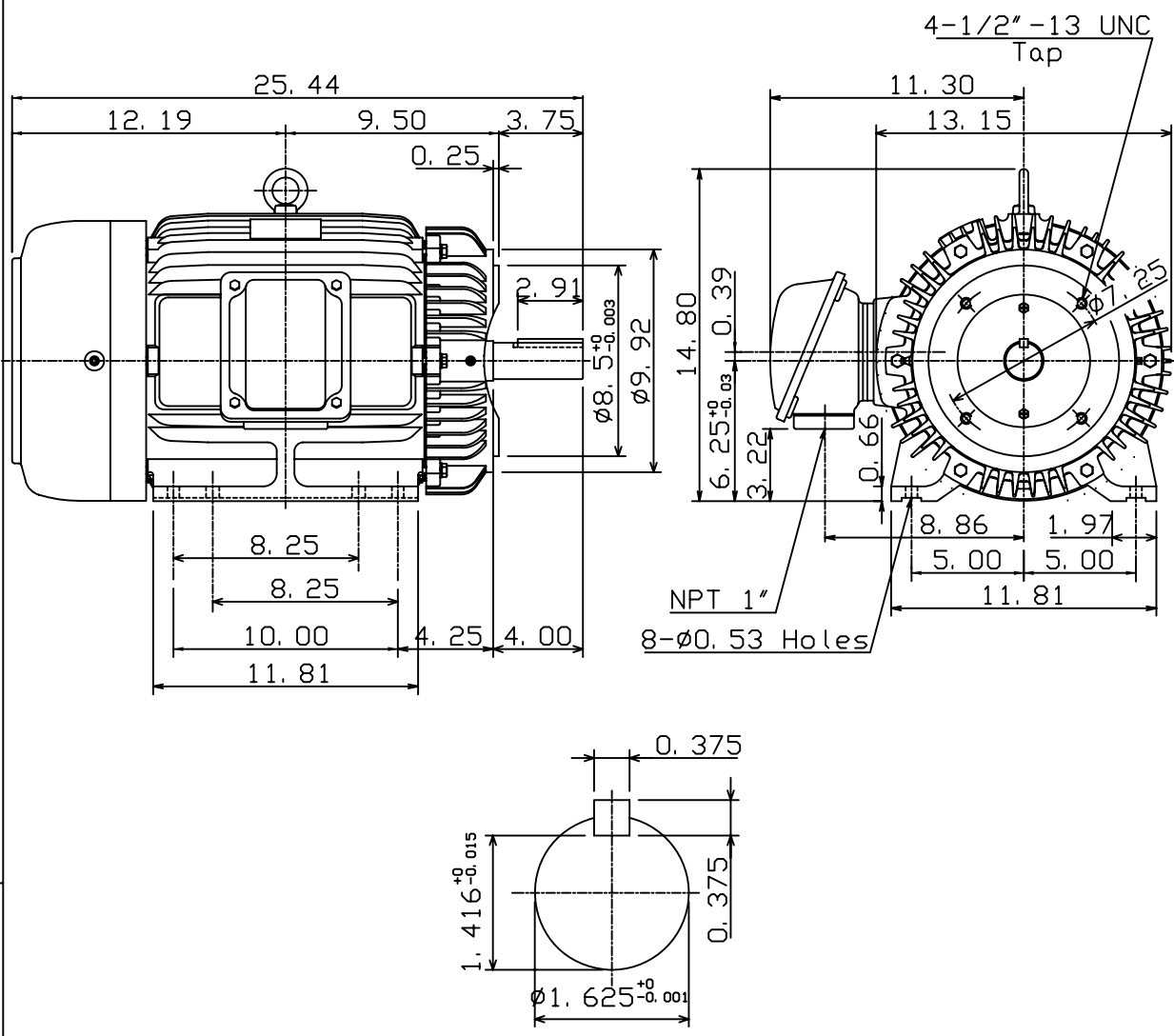

DWN.	K. L. KUO	01-10-05
CHKD.	C. H. KAO	01-28-05
APPD.	M. C. TSAI	01-28-05



DWG NO.
31049J812160