

DATE
Sept. 8, 2005
CAT. #: EPO0525

OUTLINE DIMENSIONS
3-PHASE INDUCTION MOTOR

MOTOR TYPE:
AEHH8N
FRAME NO. 184T

Pole	HP	kW	Hz	VOLT	Syn. Speed r/min(rpm)
2	5	3.7	60	575	3600

Ins	Rating	Dimension in	Approx Weight	Bearings
F	CONT.	inch	112 lbs.	DE: 6306ZZ NDE: 6306ZZ

Totally Enclosed Fan-Cooled Type, Squirrel-Cage Rotor.

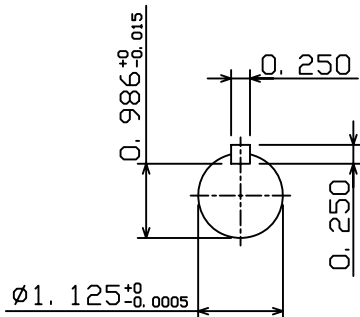
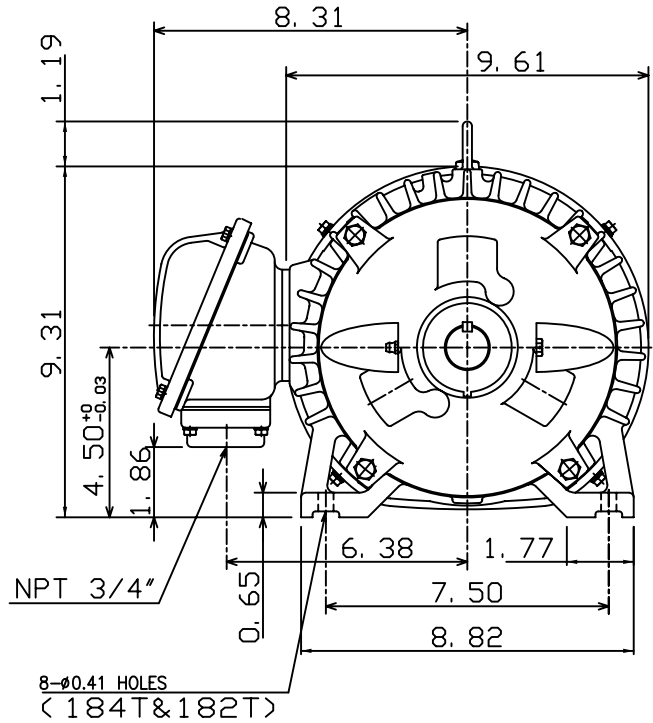
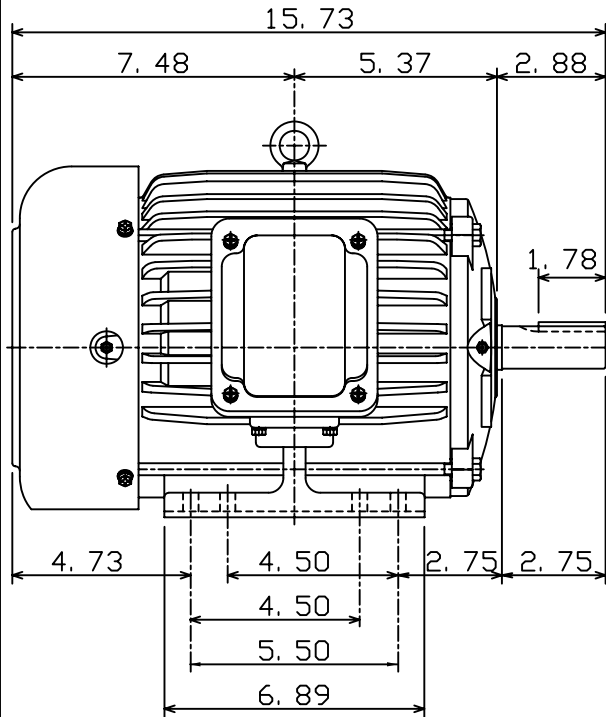

DWN.	C. S. LO	12-22-04
CHKD.	C. S. LO	12-27-04
APPD.	M. C. TSAI	12-27-04

TECO Westinghouse

DWG NO.
31057H354030