

DATE
MAY 28, 2009
CATALOG # DTP1/56

OUTLINE DIMENSIONS
3-PHASE INDUCTION MOTOR

MOTOR TYPE:
ASGH
FRAME NO. 182T

Pole	HP	kW	Hz	VOLT	Syn.Speed r/min(rpm)
6	1.5	1.12	60	230/460	1200

Ins	Rating	Dimension in	Approx Weight	Bearings
F	CONT.	inches	62 lbs.	DE: 6206ZZC3NDE: 6205ZZC3

Open Protected Drip-Proof Squirrel Cage Rotor.

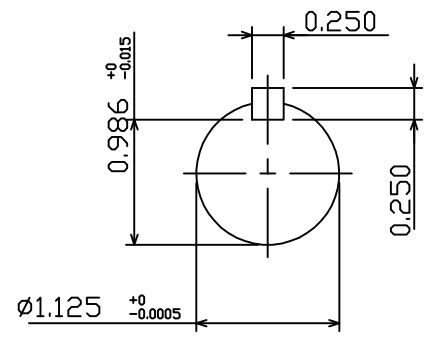
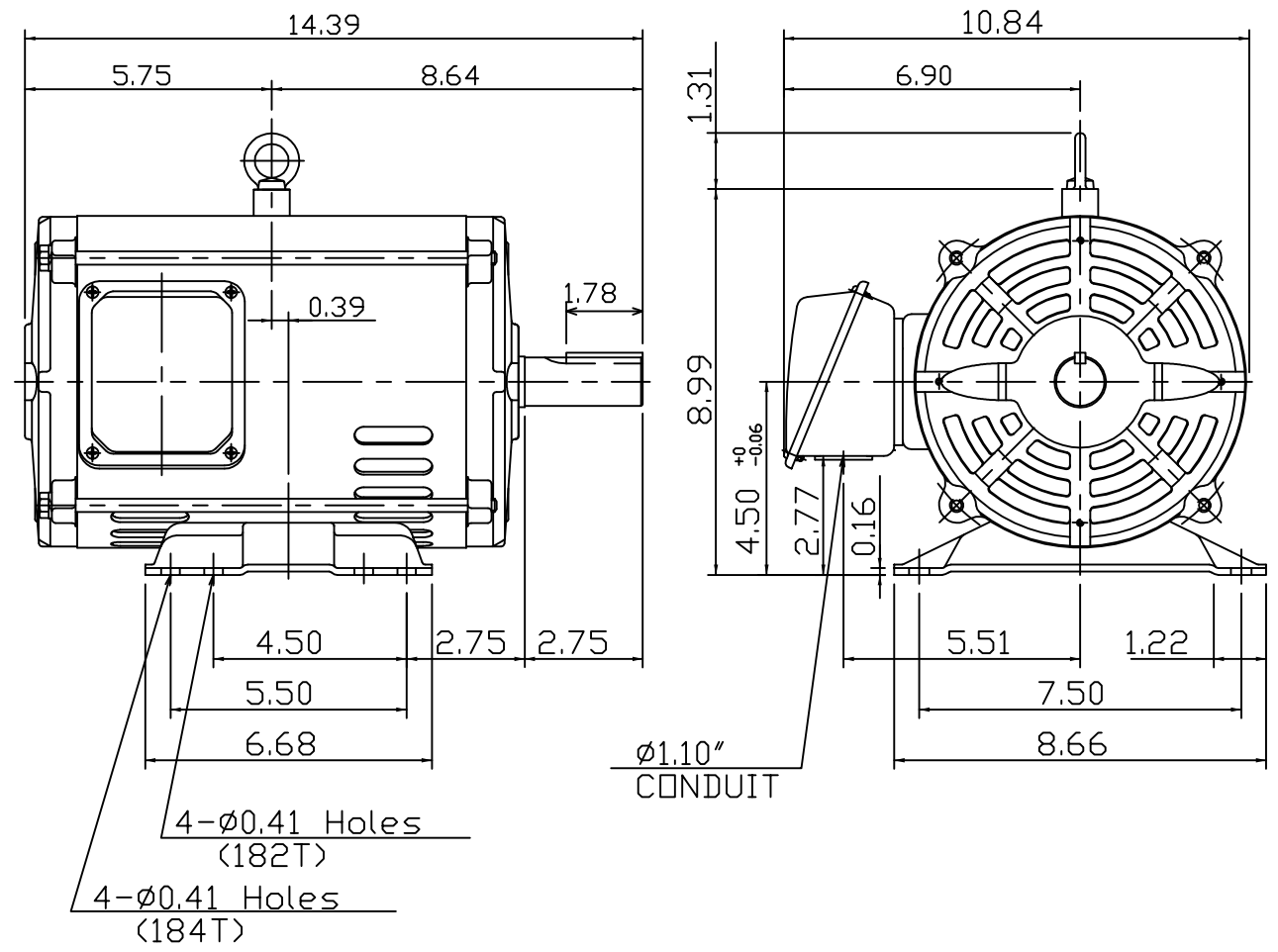

DWN.	J.H.LIANG	04-28-08
CHKD.	H.C.YAN	05-05-08
APPD.	M.C.TSAI	05-05-08



DWG NO.
31049R170010