

DATE
MAY 28, 2009
CATALOG # DTP0252G

OUTLINE DIMENSIONS
3-PHASE INDUCTION MOTOR

MOTOR TYPE:
ASGH-SGR
FRAME NO. 256T

Pole	HP	kW	Hz	VOLT	Syn.Speed r/min(rpm)
2	25	18.6	60	230/460	3600
Ins	Rating	Dimension in	Approx Weight	Bearings	
F	CONT.	inches	229 lbs.	DE: 6309ZZC3NDE: 6208ZZC3	

Open Protected Drip-Proof Squirrel-Cage Rotor.

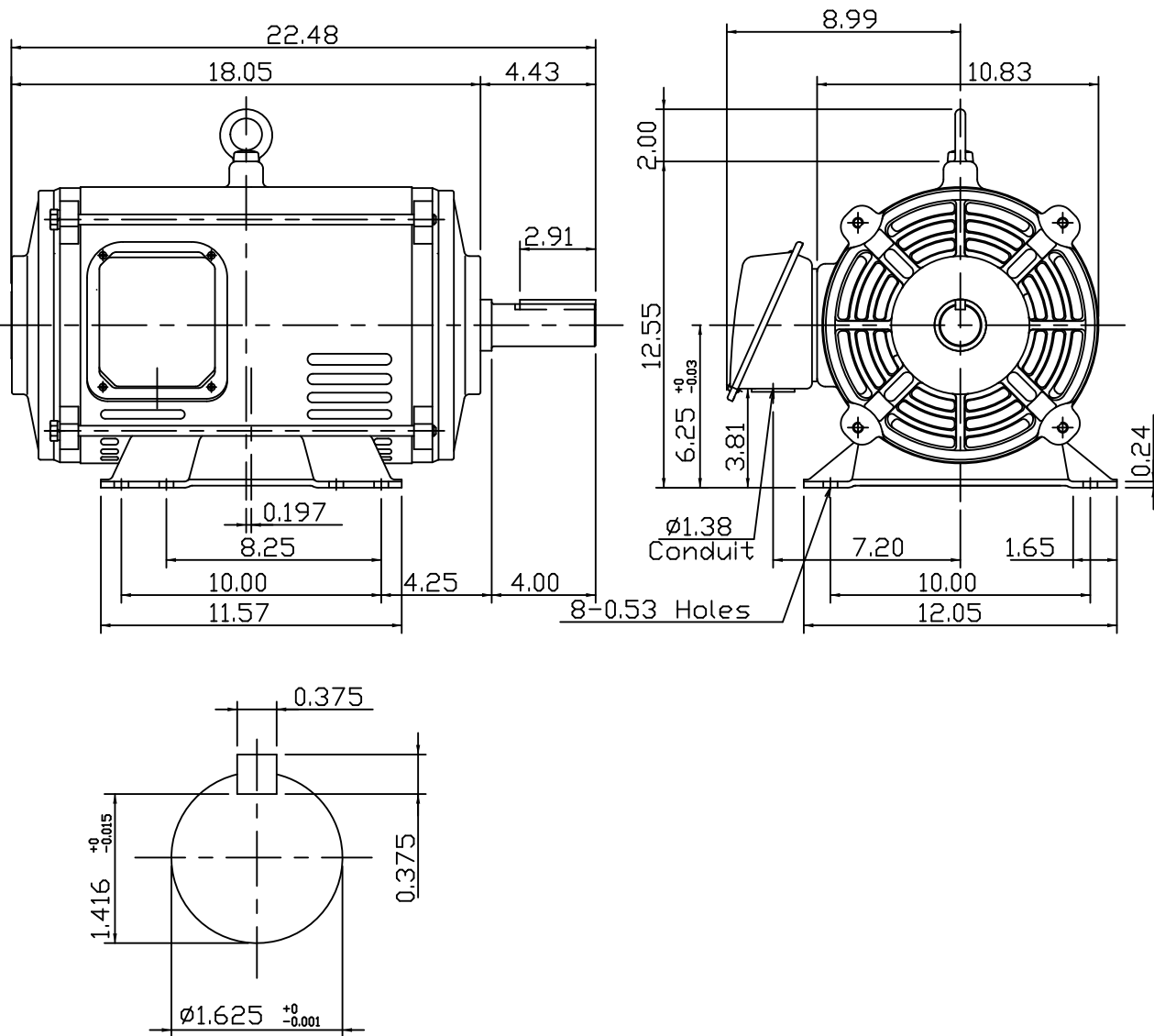

NOTE:
1.AEGIS Grounding ring installed on Drive-end.



DWN.	K.L.KUD	05-11-08
CHKD.	K.L.KUD	05-11-08
APPD.	M.C.TSAI	05-11-08



DWG NO.
31057H739140