

DATE
MAY 28, 2009
CATALOG # DTP0204

OUTLINE DIMENSIONS
3-PHASE INDUCTION MOTOR

MOTOR TYPE:
ASGH
FRAME NO. 256T

Pole	HP	kW	Hz	VOLT	Syn.Speed r/min(rpm)
4	20	14.9	60	230/460	1800

Ins	Rating	Dimension in	Approx Weight	Bearings
F	CONT.	inches	234 lbs.	DE: 6309ZZC3NDE: 6208ZZC3

Open Protected Drip-Proof Squirrel-Cage Rotor.

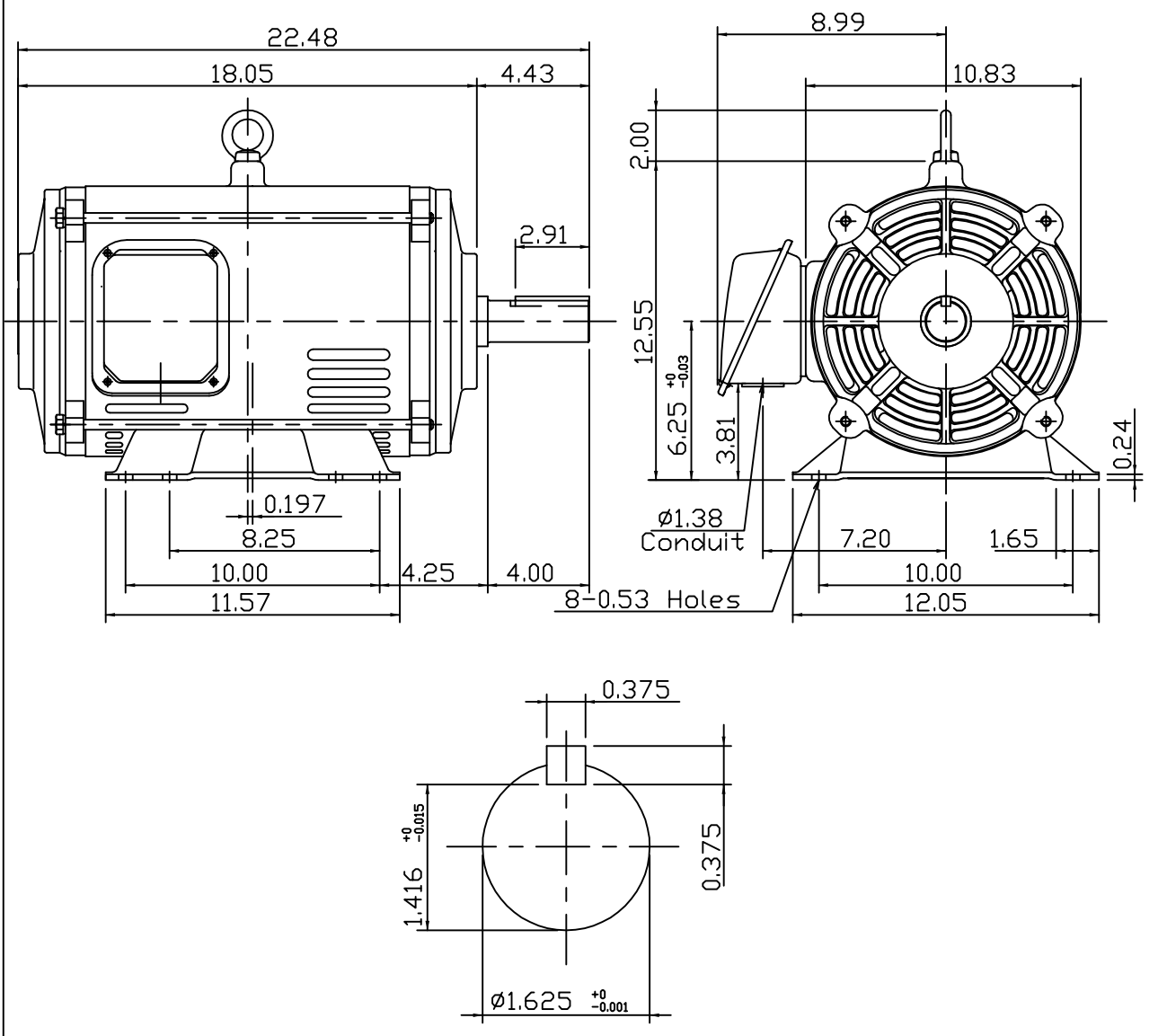

DWN.	K.L.KUD	05-11-08
CHKD.	K.L.KUD	05-11-08
APPD.	M.C.TSAI	05-11-08



DWG NO.
31057H739140