

DATE
MAY 28, 2009
CATALOG # DTP0156G

OUTLINE DIMENSIONS
3-PHASE INDUCTION MOTOR

MOTOR TYPE:
ASGH-SGR
FRAME NO. 284T

Pole	HP	kW	Hz	VOLT	Syn.Speed r/min(rpm)
6	15	11.2	60	230/460	1200
Ins	Rating	Dimension in	Approx Weight	Bearings	
F	CONT.	inches	278 lbs.	DE: 6311ZZC3 NDE: 6211ZZC3	

Open Protected Drip-Proof Type.Squirrel-cage Rotor.

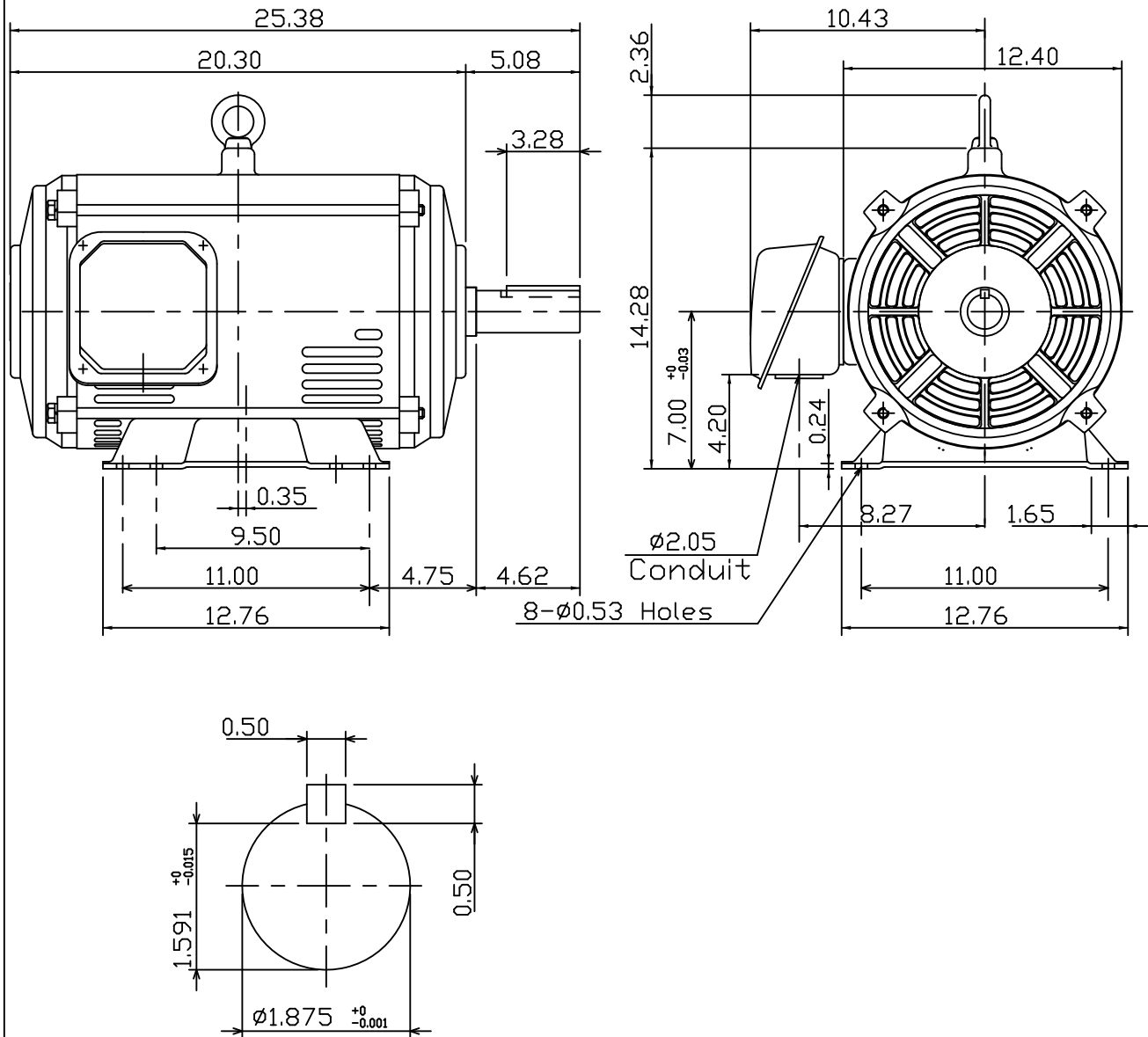

NOTE:
1.AEGIS Grounding ring installed on Drive-end.



DWN.	K.L.KUD	04-28-08
CHKD.	K.L.KUD	05-05-08
APPD.	M.C.TSAI	05-05-08



DWG NO.
31057H724060