

DATE MAY 28, 2009	OUTLINE DIMENSIONS 3-PHASE INDUCTION MOTOR	MOTOR TYPE: ASGH
CATALOG # DTP0032		FRAME NO. 145T

Pole	HP	kW	Hz	VOLT	r/min
2	3	2.24	60	230/460	3600

Ins	Rating	Dimension in	Approx Weight	Bearings
F	CONT.	inch.	35 lbs.	DE: 6205ZZ NDE: 6204ZZ

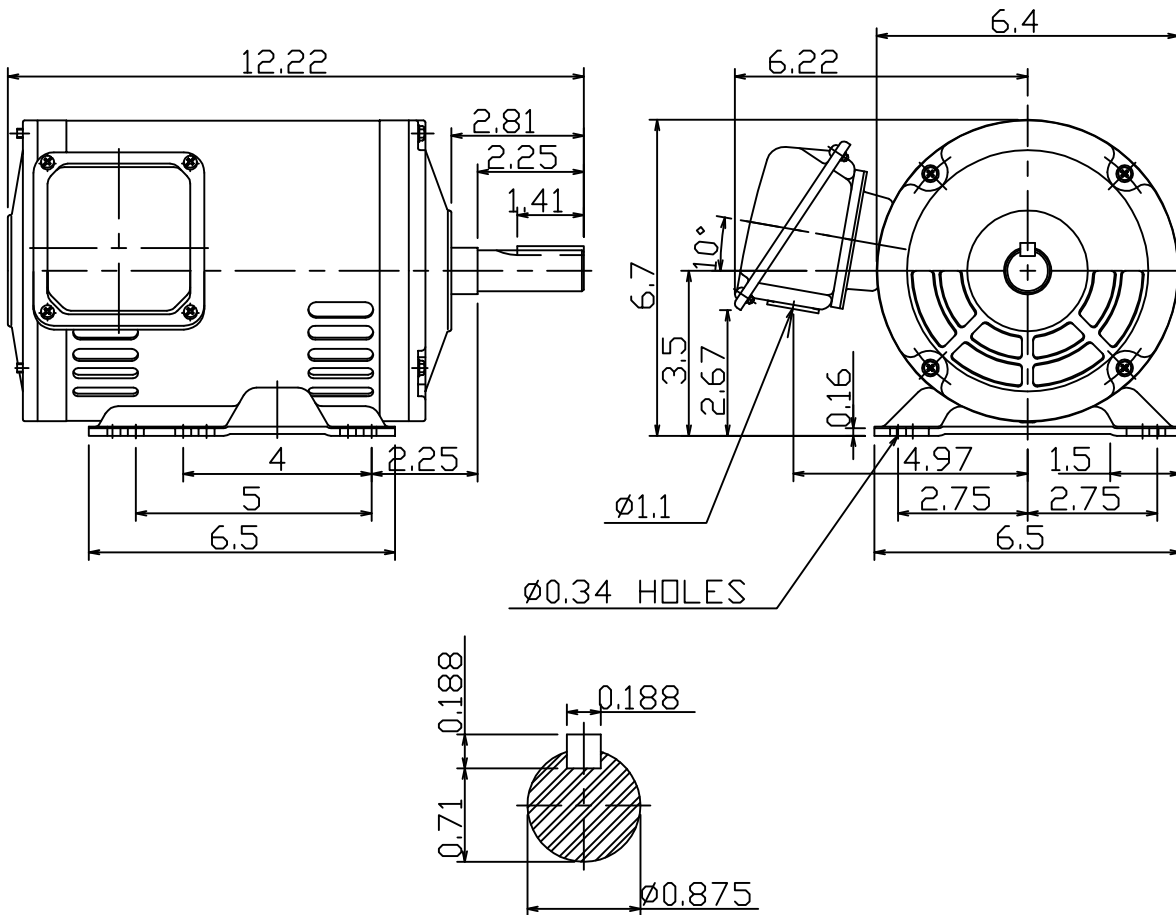

DWN.	陳奕元	01 12 09	東元電機股份有限公司 TECO Electric & Machinery Co., Ltd. TAIWAN	DWG NO. 31049Z107370
CHKD.	陳敬元	01 16 09		
APPD.	蔡明釗	01 16 09		