

DATE  
MAY 28, 2009  
CATALOG # DTP0016

OUTLINE DIMENSIONS  
3-PHASE INDUCTION MOTOR

MOTOR TYPE:  
ASGH  
FRAME NO. 145T

Pole	HP	kW	Hz	VOLT	r/min
6	1	0.75	60	230/460	1200

Ins	Rating	Dimension in	Approx Weight	Bearings
F	CONT.	inch.	36 lbs.	DE: 6205ZZ NDE: 6204ZZ

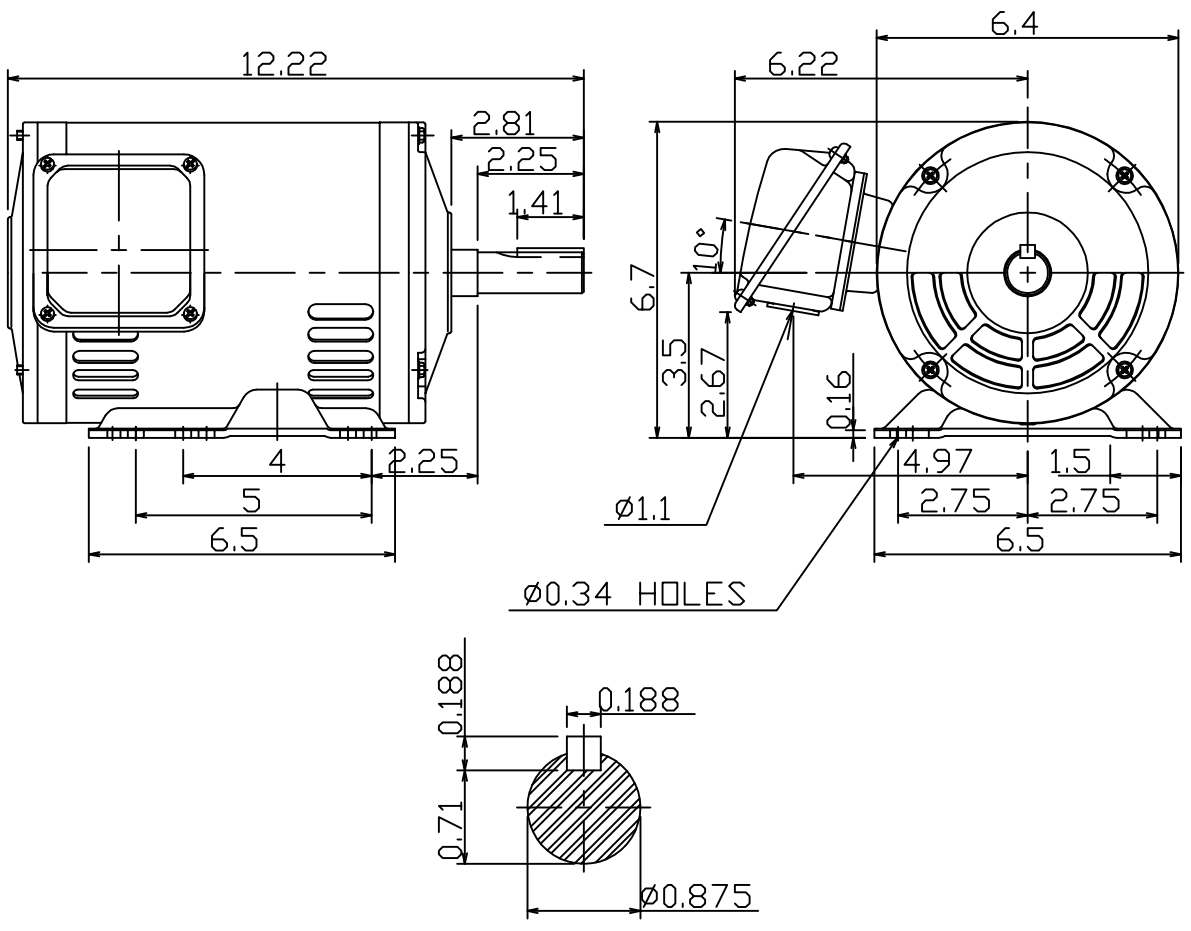

DWN.	陳奕元	01 12 09
CHKD.	陳敬元	01 16 09
APPD.	蔡明釗	01 16 09

東元電機股份有限公司  
TECO Electric & Machinery Co., Ltd.  
TAIWAN

DWG NO.  
31049Z107370