

DATE
MAY 28, 2009
CATALOG # DTP0014G

OUTLINE DIMENSIONS
3-PHASE INDUCTION MOTOR

MOTOR TYPE:
ASGH-SGR
FRAME NO. 143T

Pole	HP	kW	Hz	VOLT	r/min
4	1	0.75	60	230/460	1800

Ins	Rating	Dimension in	Approx Weight	Bearings
F	CONT.	inch.	35 lbs.	DE: 6205ZZ NDE: 6204ZZ

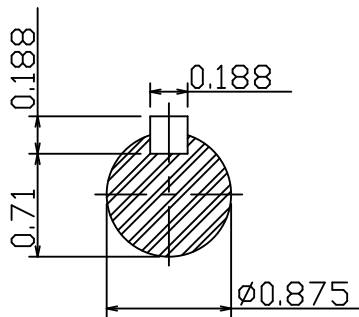
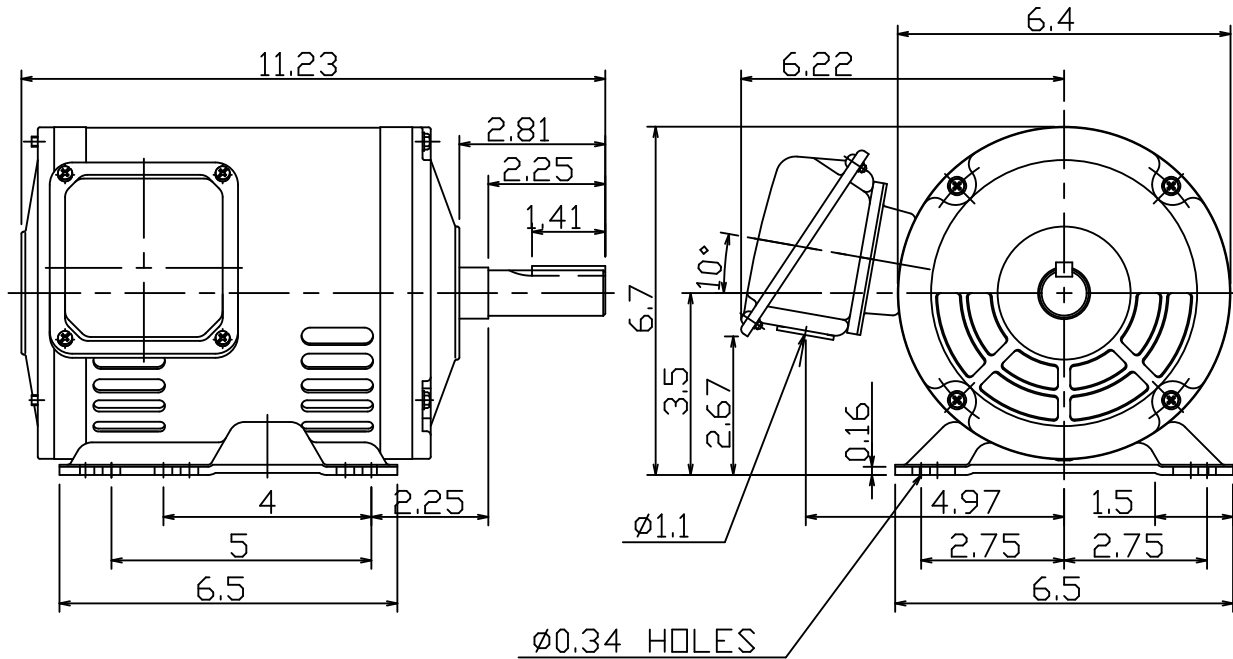

NOTE:
1.AEGIS Grounding ring installed on Drive-end.



DWN.	陳奕元	01 12 09
CHKD.	陳敬元	01 16 09
APPD.	蔡明	01 16 09

東元電機股份有限公司
TECO Electric & Machinery Co., Ltd.
TAIWAN

DWG NO.
31049Z107360