

TYPE	OUTPUT		POLE	TIME RATING CNT.	VOLTAGE V	Hz	SYN SPEED R.P.M
	HP.	KW.					
ASHH	200	149.2	4		380	50	1500

DRIP PROOF TYPE, SQUIRREL-CAGE ROTOR

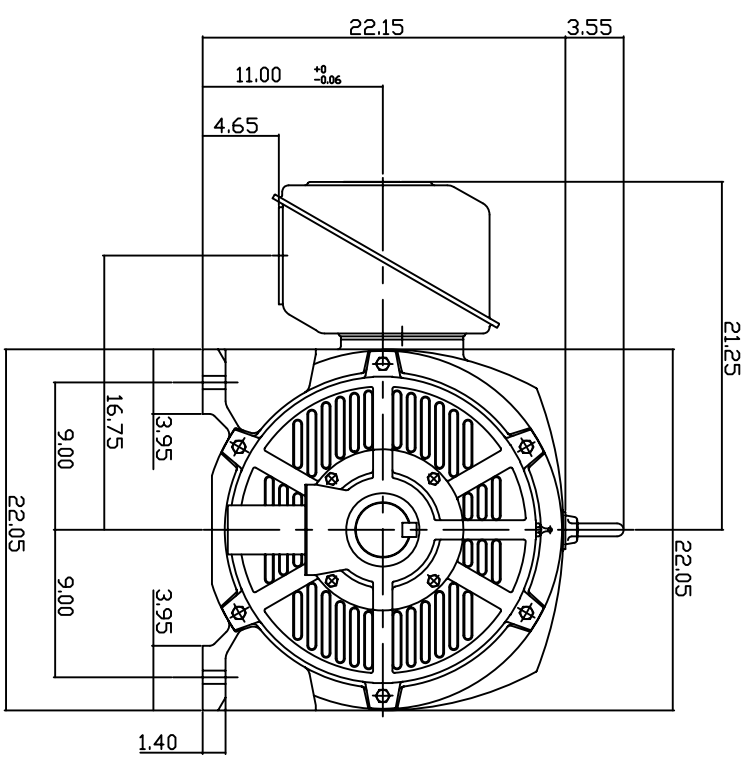
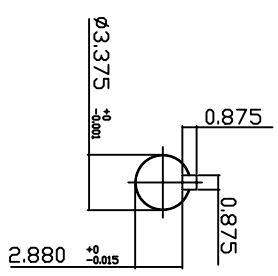
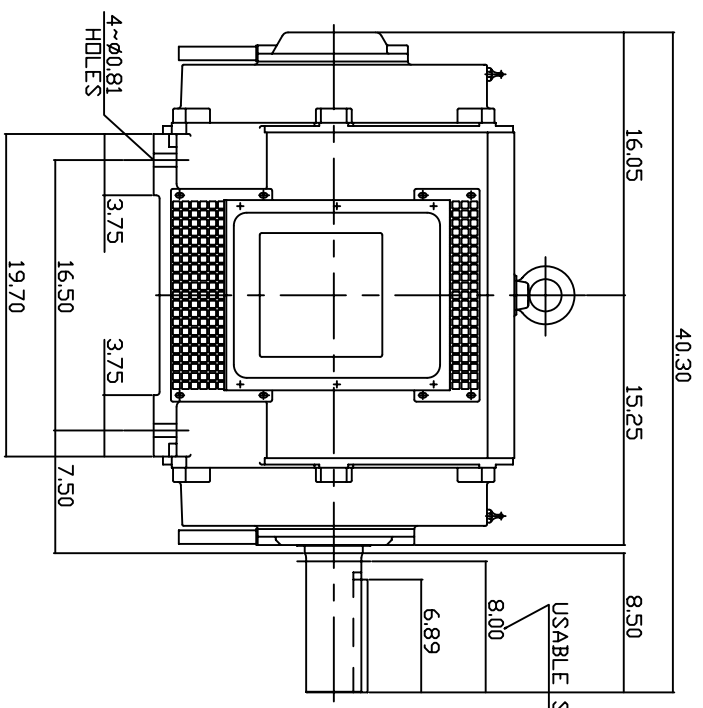

NOTE:

1. DIMENSIONS IN INCH.
2. FRAME ND445T
3. F CLASS INSULATION, S.F.1.0
4. FOR DIRECT DRIVE
5. BEARING SIZE: DRIVE END: 6318
NON-DRIVE END: 6316
6. MOTOR APPROX. WEIGHT: 1430LBS

TB-56SSC

DWN.	V.L.LIN	MAR-26-2003
CHKD.	W.L.LIN	MAR-26-2003
APPD.	C.VANG	MAR-26-2003

DATE May 25, 2007
 Cat # DHP2004-50
 OUTLINE DIMENSIONS
 3-PHASE INDUCTION MOTOR



DWG NO. 3A040T261
 REV: 00