

DATE
February 24, 2007
CATALOG NO.
DHP0604

OUTLINE DIMENSIONS
3-PHASE INDUCTION MOTOR

MOTOR TYPE:
ASHH
FRAME NO. 364T

Pole	HP	KW	Hz	VOLT	Syn. Speed RPM
4	60	45	60	230/460	1800

Ins	Rating	Dimension in	Approx Weight	Bearings	
F	CONT.	inch	699 lbs.	DE: 6314	NDE: 6213

Open Protected Drip-Proof Squirrel-Cage Rotor.

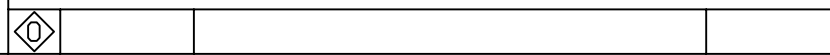
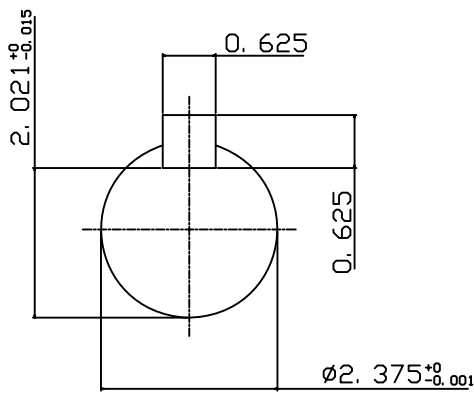
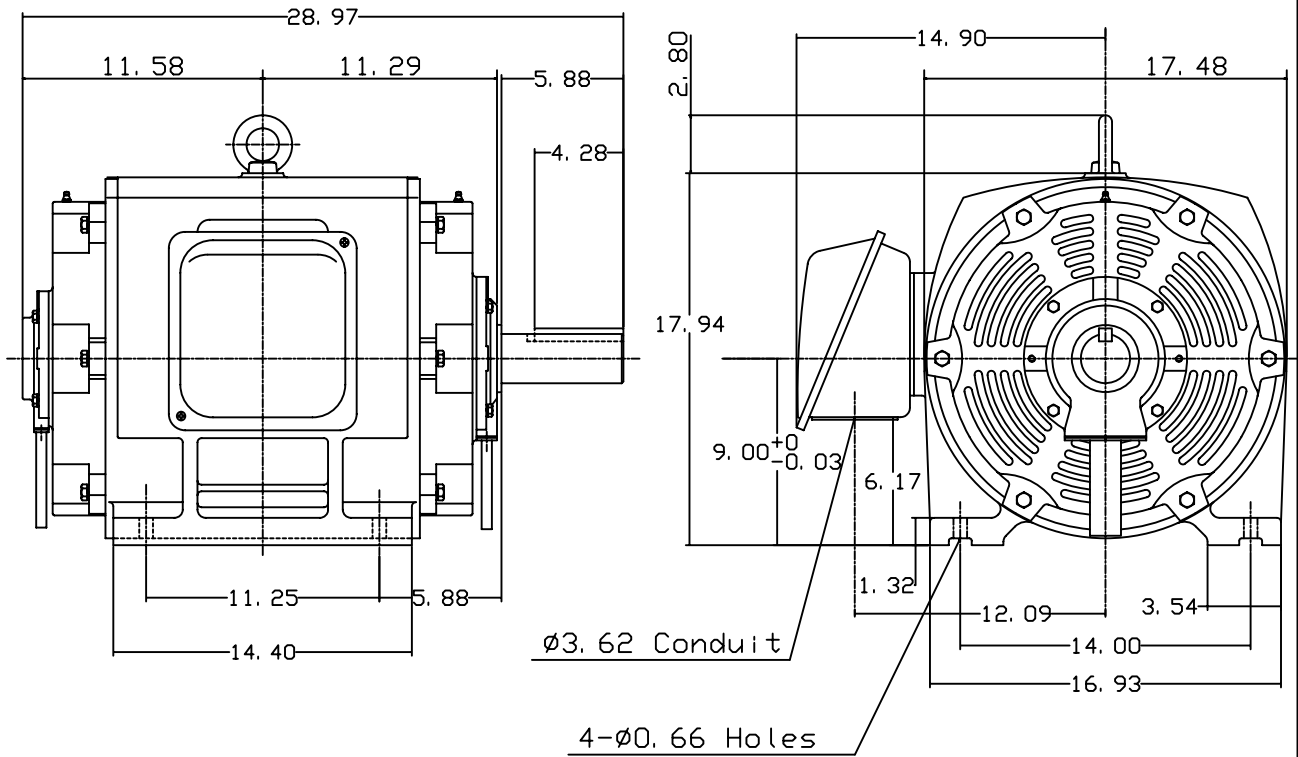

DWN.	J. H. LIANG	12-22-98
CHKD.	C. H. KAO	06-10-99
APPD.	Y. B. HUANG	06-10-99



DWG NO.
31057H394001