

DATE
FEBRUARY 23, 2007
CATALOG NO.
DHPO106

OUTLINE DIMENSIONS
3-PHASE INDUCTION MOTOR

MOTOR TYPE:
ASHH
FRAME NO. 256T

Pole	HP	KW	Hz	VOLT	Syn. Speed RPM
6	10	7.5	60	230/460	1200

Ins	Rating	Dimension in	Approx Weight	Bearings
F	CONT.	inch	287 lbs.	DE: 6310zz NDE: 6309zz

Open Protected Drip-Proof Squirrel-Cage Rotor.

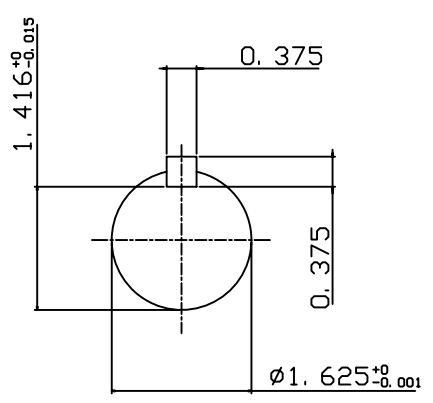
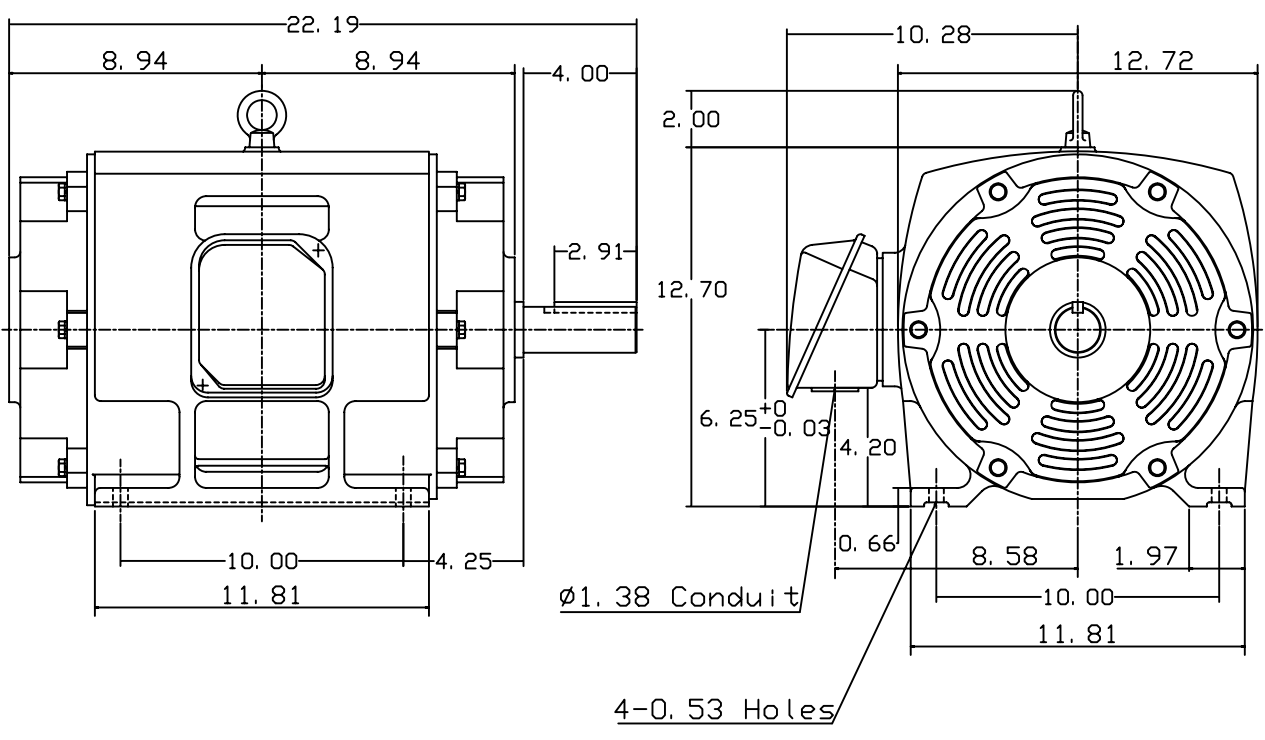

DWN.	J. H. LIANG	12-22-98
CHKD.	C. H. KAO	06-10-99
APPD.	Y. B. HUANG	06-10-99



DWG NO.
31057H384000