

DATE
FEBRUARY 23, 2007
CATALOG NO.
DHP0026

OUTLINE DIMENSIONS
3-PHASE INDUCTION MOTOR

MOTOR TYPE:
ASHH
FRAME NO. 184T

Pole	HP	KW	Hz	VOLT	Syn. Speed RPM
6	2	1.5	60	230/460	1200

Ins	Rating	Dimension in	Approx Weight	Bearings
F	CONT.	inch	106 lbs.	DE: 6306ZZ NDE: 6306ZZ

Open Protected Drip-Proof. Squirrel-cage Rotor.

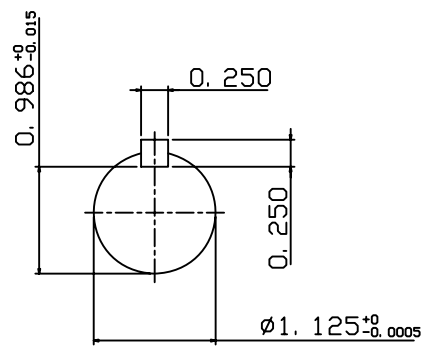
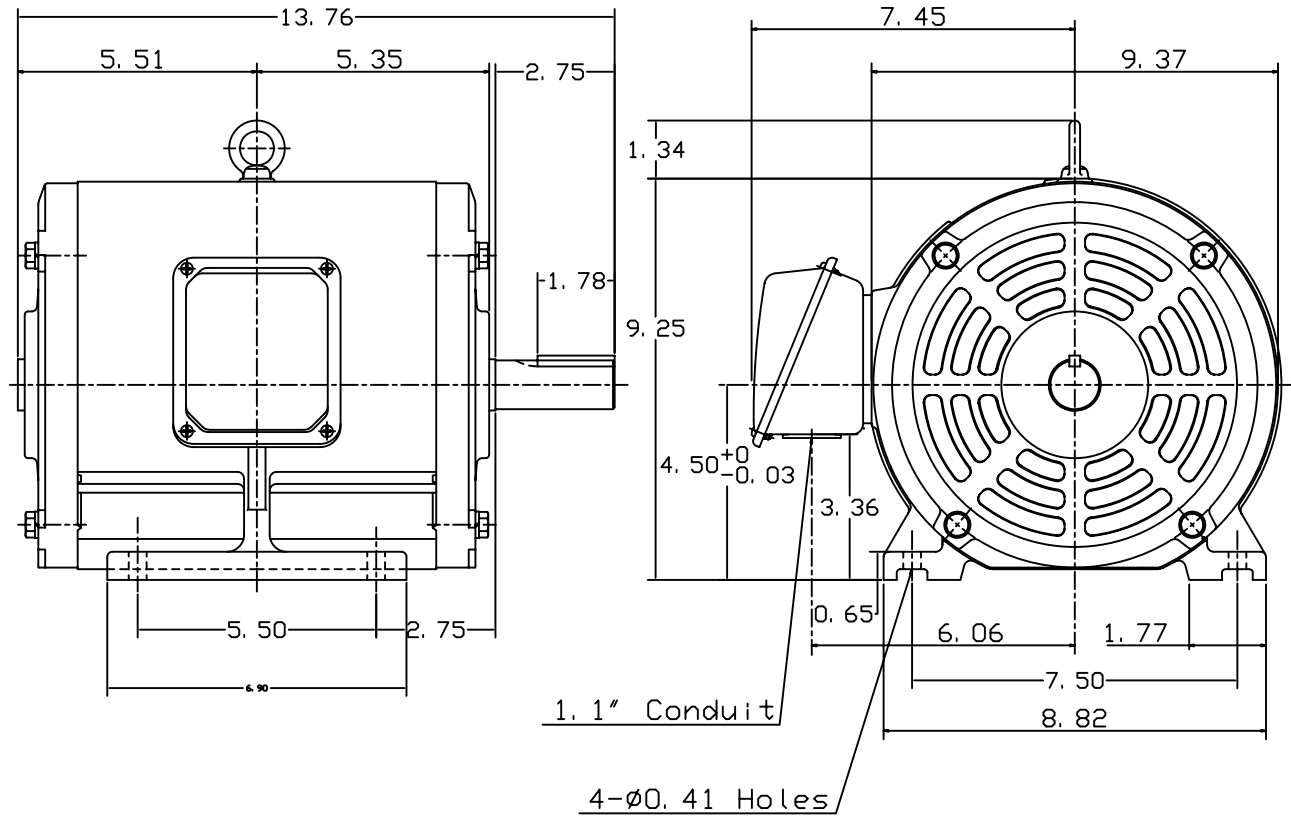

DWN.	J. H. LIANG	12-22-98
CHKD.	C. S. LO	05-20-99
APPD.	Y. B. HUANG	05-20-99



DWG NO.
31057H380000