

DATE
February 20, 2007
CATALOG NO.
DHP0024-50

OUTLINE DIMENSIONS
3-PHASE INDUCTION MOTOR

MOTOR TYPE:
ASHH
FRAME NO. 145T

Pole	HP	KW	Hz	VOLT	Syn. Speed RPM
4	2	1.5	50	190/380	1500

Ins	Rating	Dimension in	Approx Weight	Bearings
F	CONT.	inch	66 lbs.	DE: 6205ZZ NDE: 6205ZZ

Open Protected Drip-Proof Squirrel Cage Rotor.

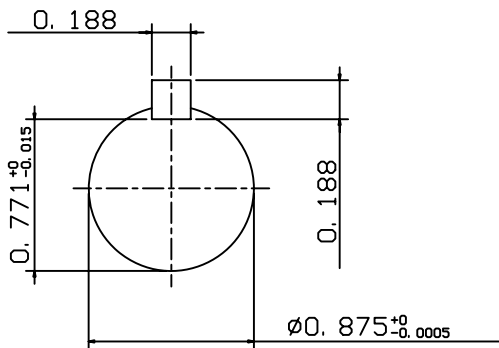
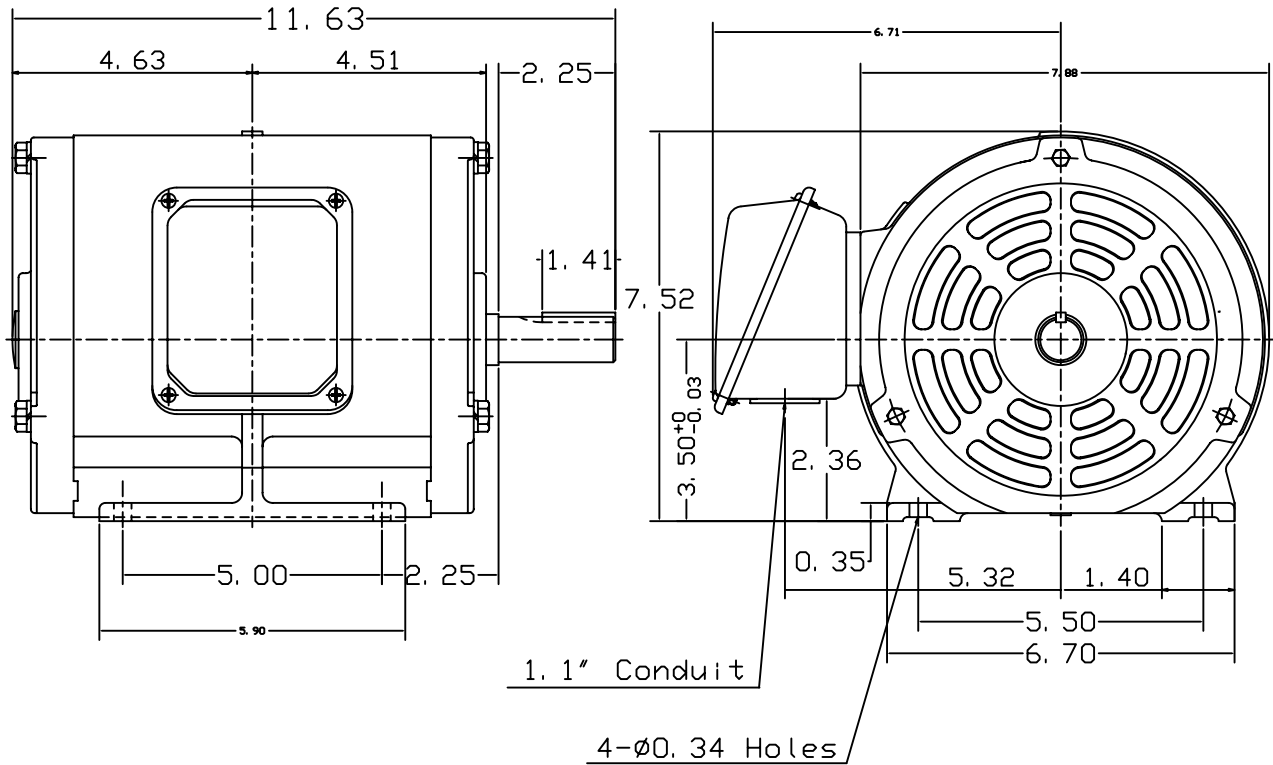

DWN.	J. H. LIANG	12-22-98
CHKD.	C. S. LO	05-20-99
APPD.	Y. B. HUANG	05-20-99

TECO Westinghouse

DWG NO.
31057H378002