

## GENERAL DATASHEET VARIABLE SPEED DRIVE

SERIES <b>F510</b>		MODEL# <b>F510-2002-C-U</b>		
ISSUED <b>3/30/2017</b>		ENCLOSURE/ FRAME <b>NEMA 1 (IP20) / F1</b>		
SINGLE PHASE INPUT AMPS ND (VT) <b>14.1</b>		AC INPUT VOLTAGE <b>200-240</b>	AC INPUT FREQUENCY <b>50/60</b>	AC INPUT PHASE <b>1/3</b>
THREE PHASE INPUT AMPS ND(VT) <b>8.1</b>				
OUTPUT HP ND (VT) <b>2</b>	OUTPUT AMPS ND (VT) <b>7.5</b>	AC OUTPUT VOLTAGE <b>0-240</b>	AC OUTPUT FREQUENCY <b>0-400</b>	AC OUTPUT PHASE <b>3</b>

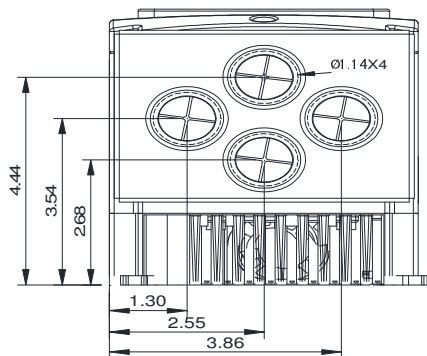
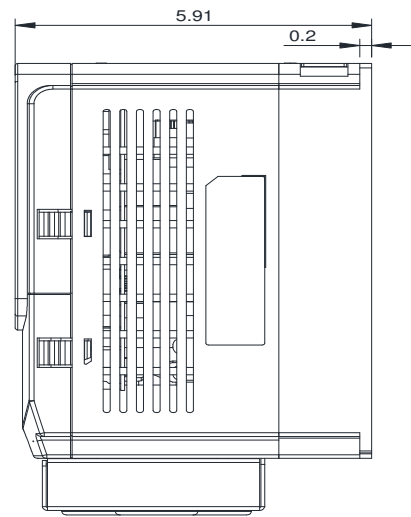
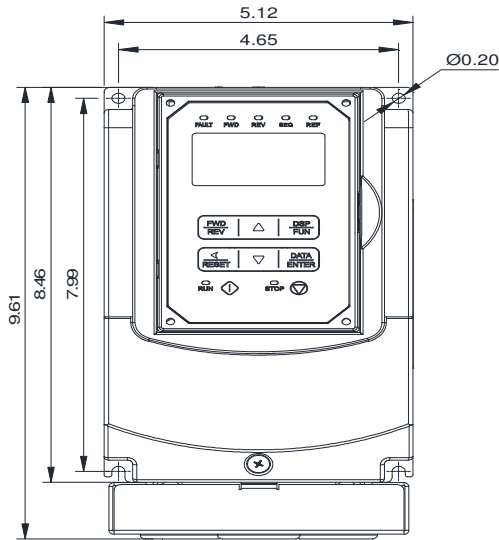

Approved By:	Brian Smith	Drawing No:	F510-230-002-F1	Revision: 0
--------------	-------------	-------------	-----------------	-------------