

DATE:
June 1, 2005

CONNECTION DIAGRAM

CATALOG NO.:
Q0256

ACROSS THE LINE CONNECTION

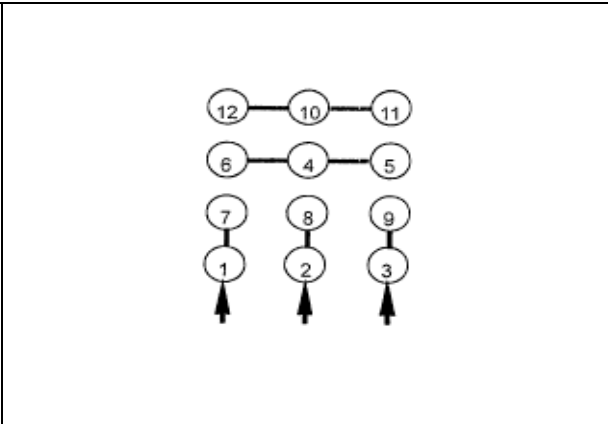
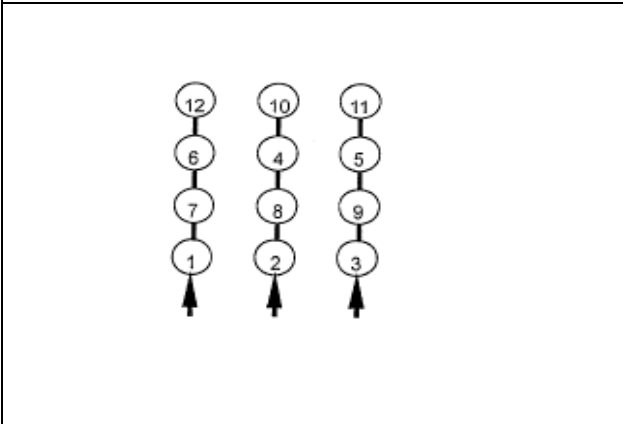

LINE □ 230 VOLT CONNECTION

LINE □ 460 VOLT CONNECTION

ACROSS THE LINE CONNECTION

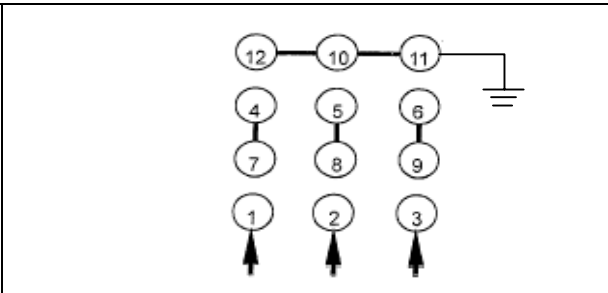
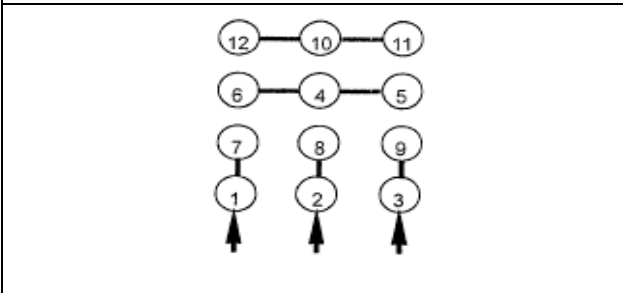

**LINE
398 VOLT CONNECTION**

**LINE
460 VOLT CONNECTION**

WHEN WYE CONNECTION, FOR USED ON 796 VOLTS, MUST BE SOLIDLY GROUNDED SYSTEM NEUTRAL

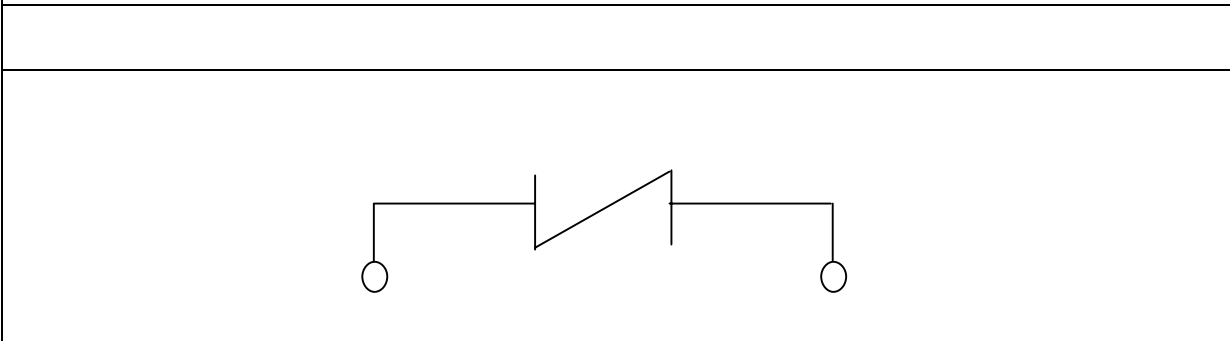

THERMAL PROTECTOR TYPE 9700K76-215



DWG NO.
DAC-1565-4