

DATE:
May 28, 2009

CONNECTION DIAGRAM

CATALOG NO.:
GP0022

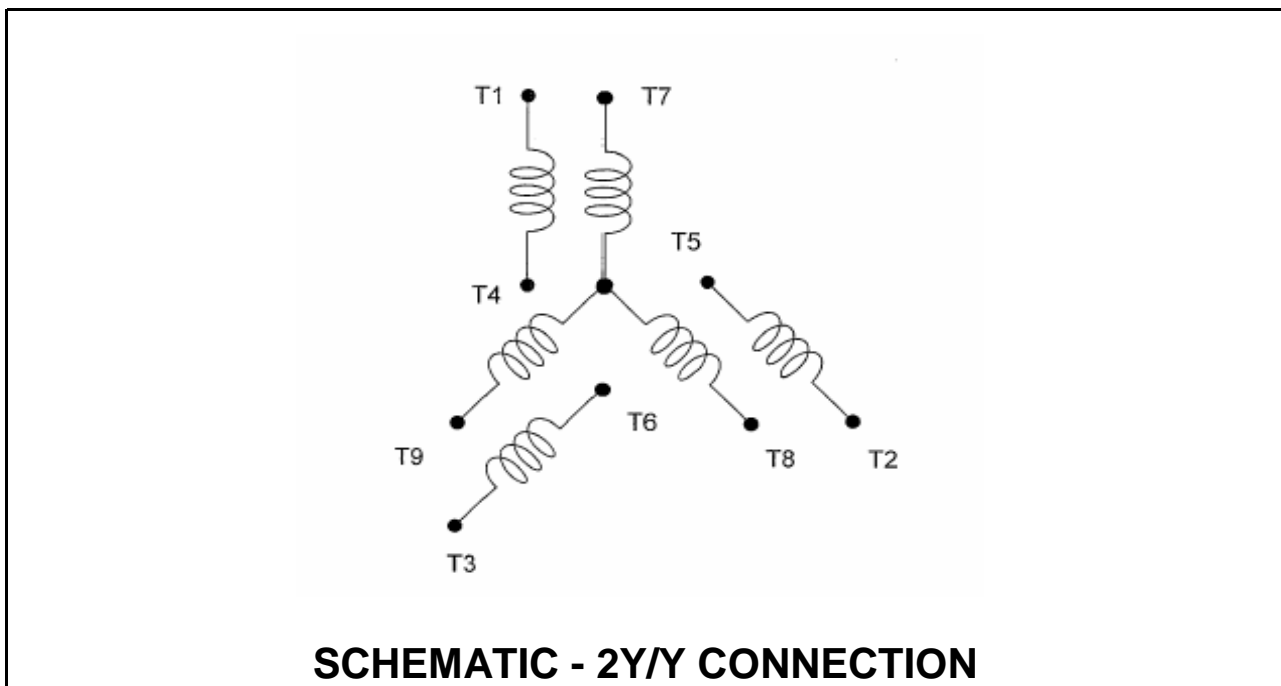

ACROSS THE LINE CONNECTION

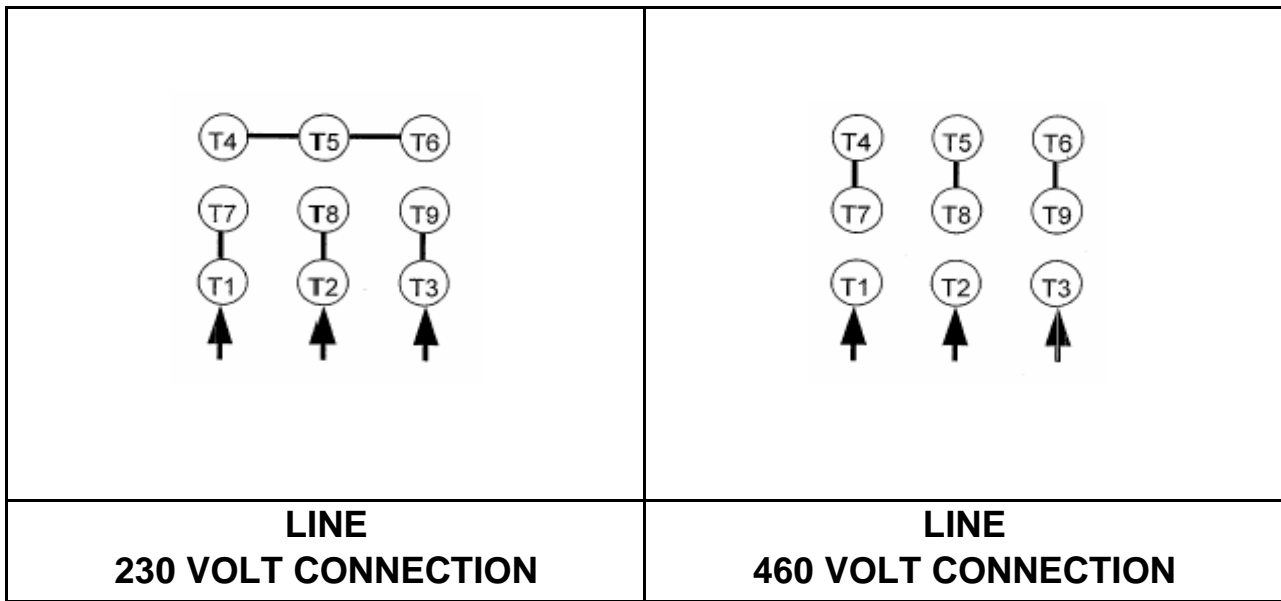

DWG NO.
DAC-1566-2