

DATE:  
September 13, 2006

# CONNECTION DIAGRAM

CATALOG NO.:  
EPV1/56C

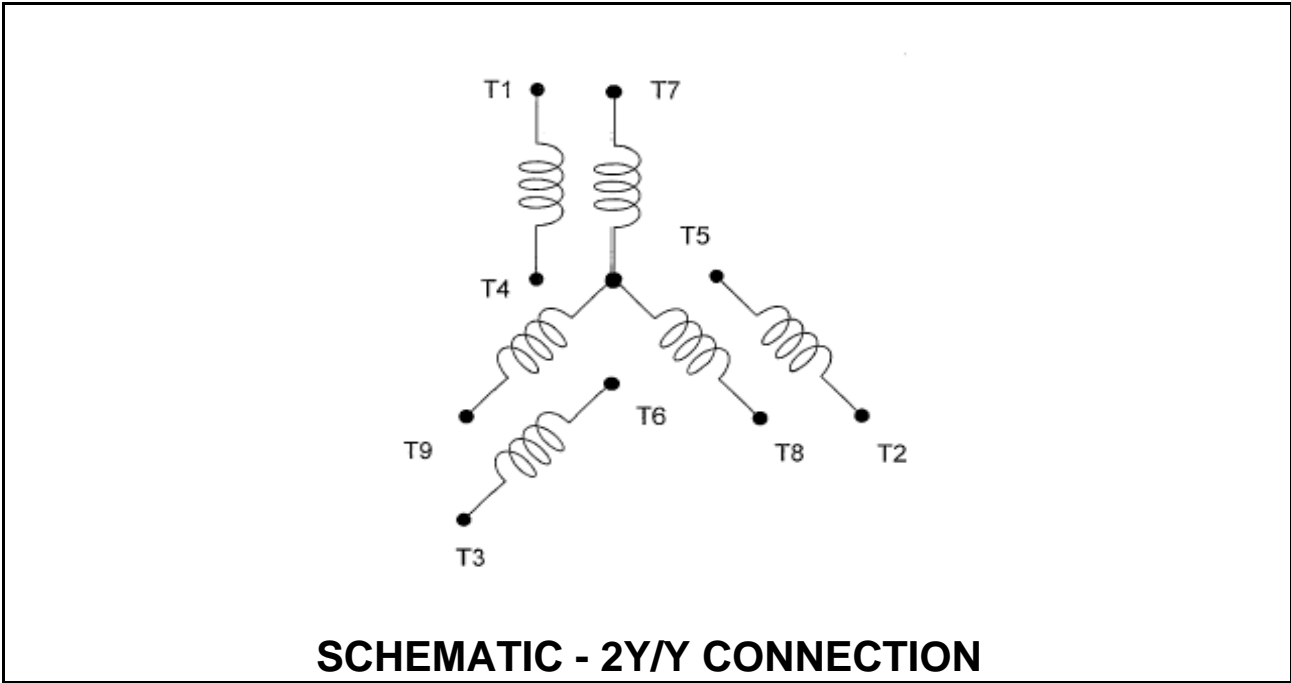

## ACROSS THE LINE CONNECTION

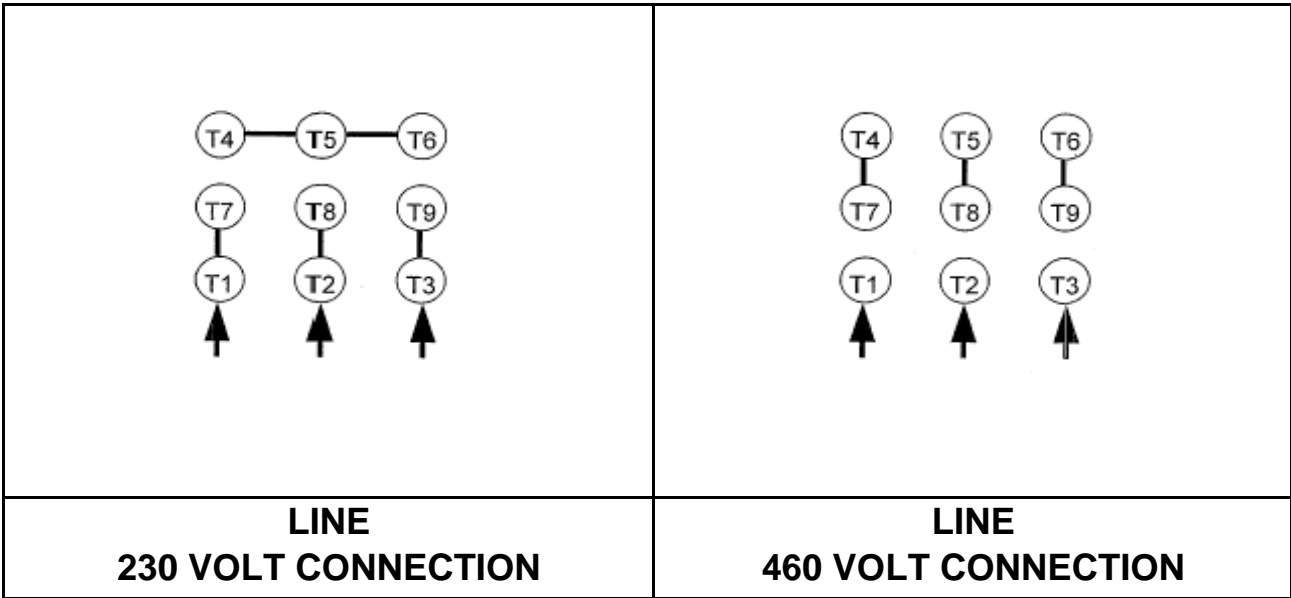

**TECO**  **Westinghouse**

DWG NO.  
**DAC-1566-2**