

DATE:  
December 2, 2005

# CONNECTION DIAGRAM

CATALOG NO.:  
EP1006R

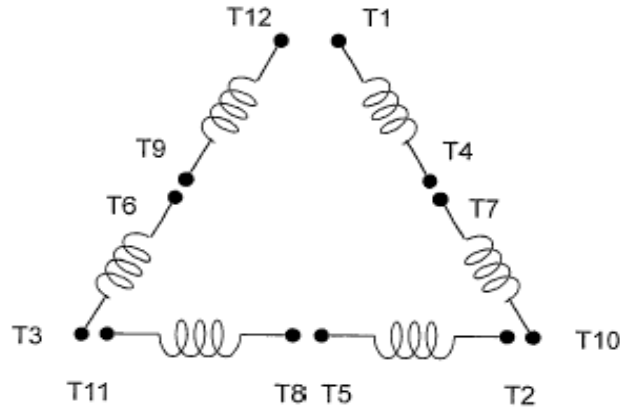

**SCHEMATIC - Δ / Y CONNECTION**

## ACROSS THE LINE CONNECTION

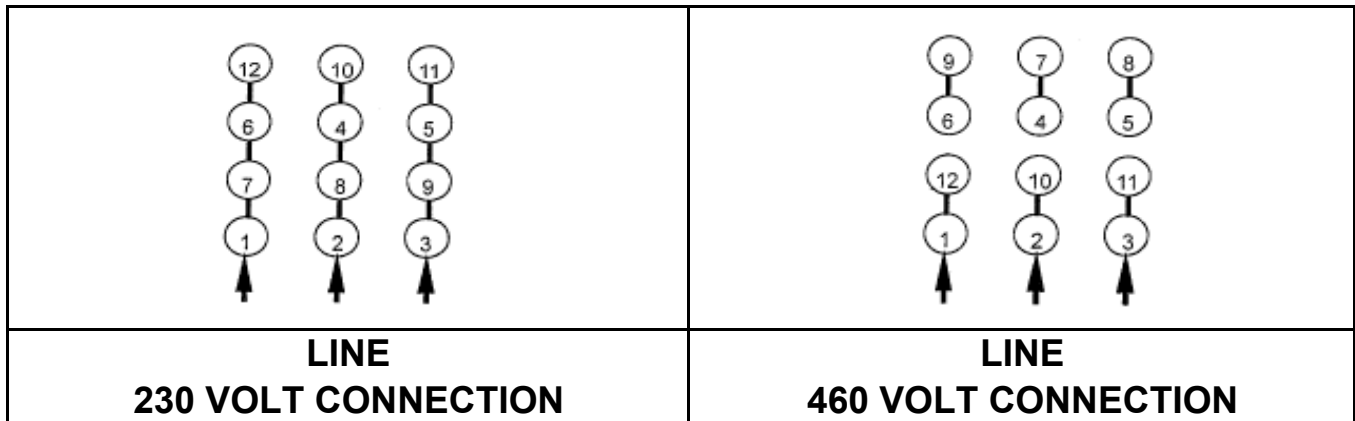

## WYE START-DELTA RUN CONNECTION

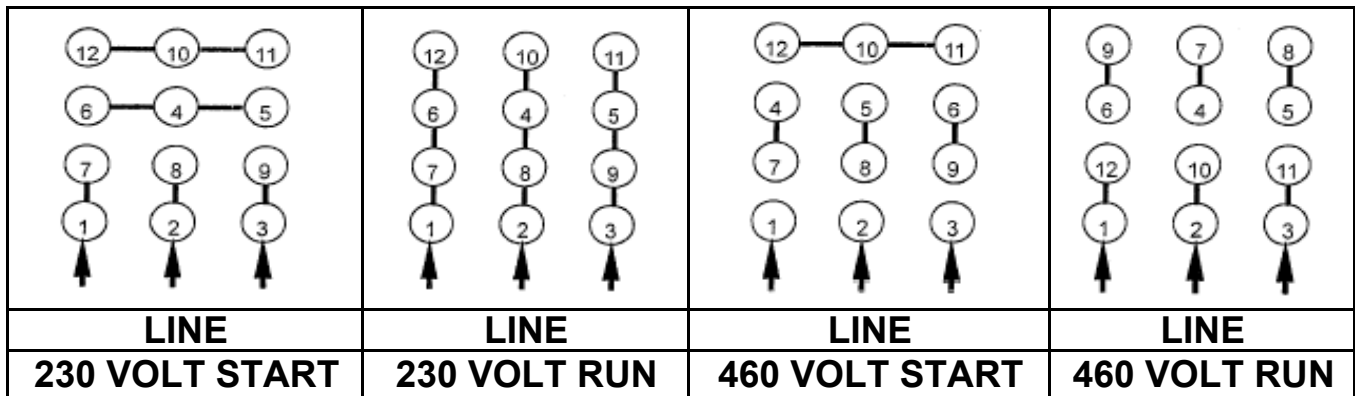

DWG NO.  
**DAC-1565-4**