

DATE:
October 3, 2005

CONNECTION DIAGRAM

CATALOG NO.:
EP1004-50



SCHEMATIC - Δ / Y CONNECTION

ACROSS THE LINE CONNECTION

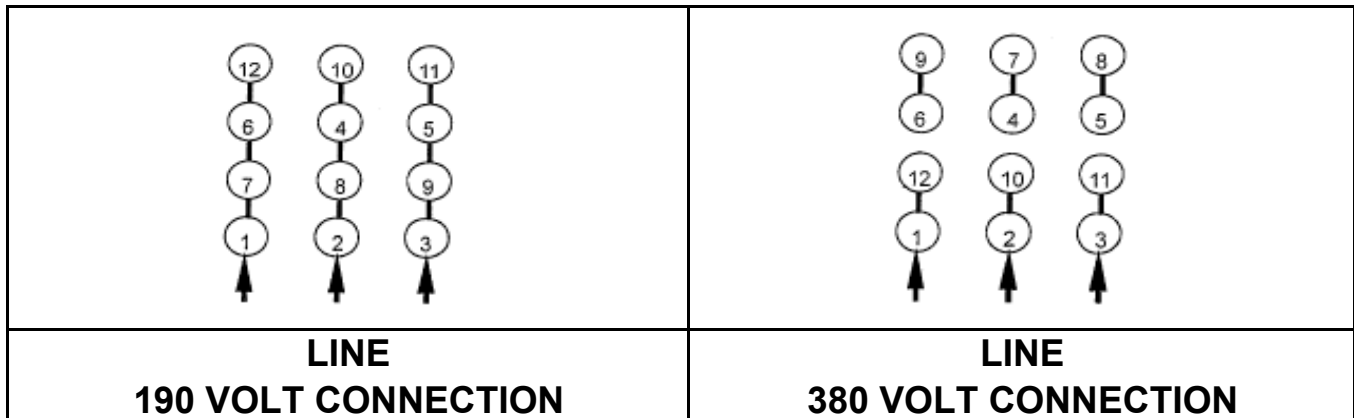

WYE START-DELTA RUN CONNECTION

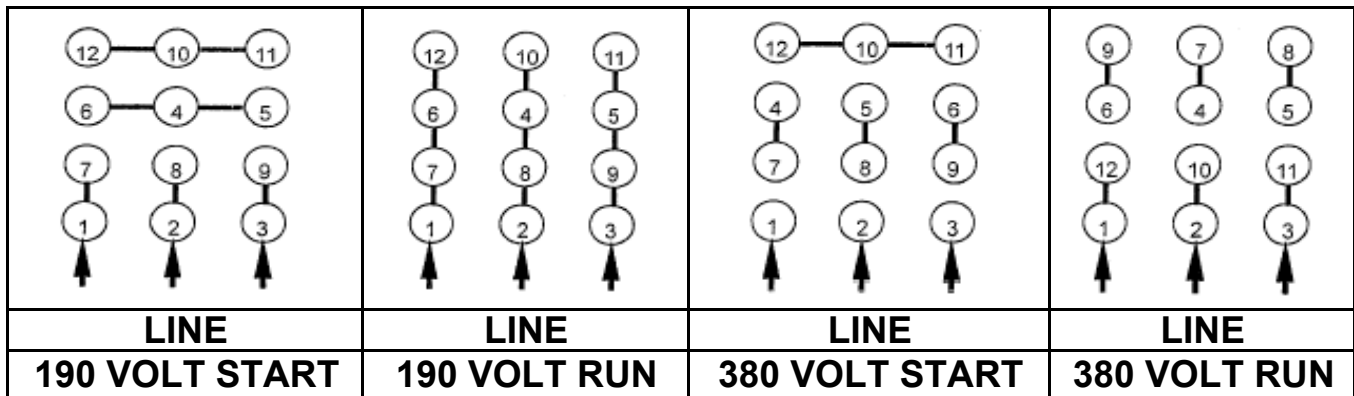

DWG NO.
DAC-1565-4