

DATE:
June 22, 2005

CONNECTION DIAGRAM

CATALOG NO.:
EP0506

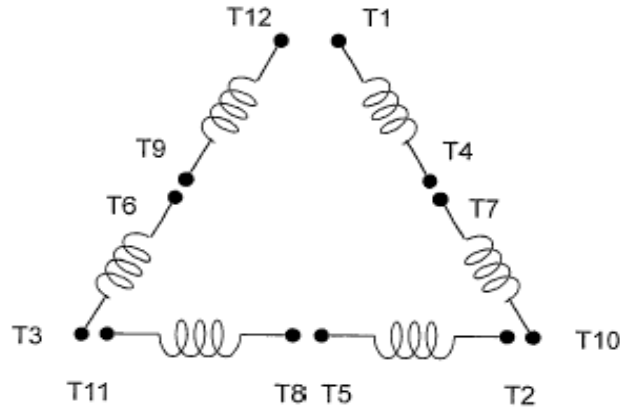

SCHEMATIC - Δ / Y CONNECTION

ACROSS THE LINE CONNECTION

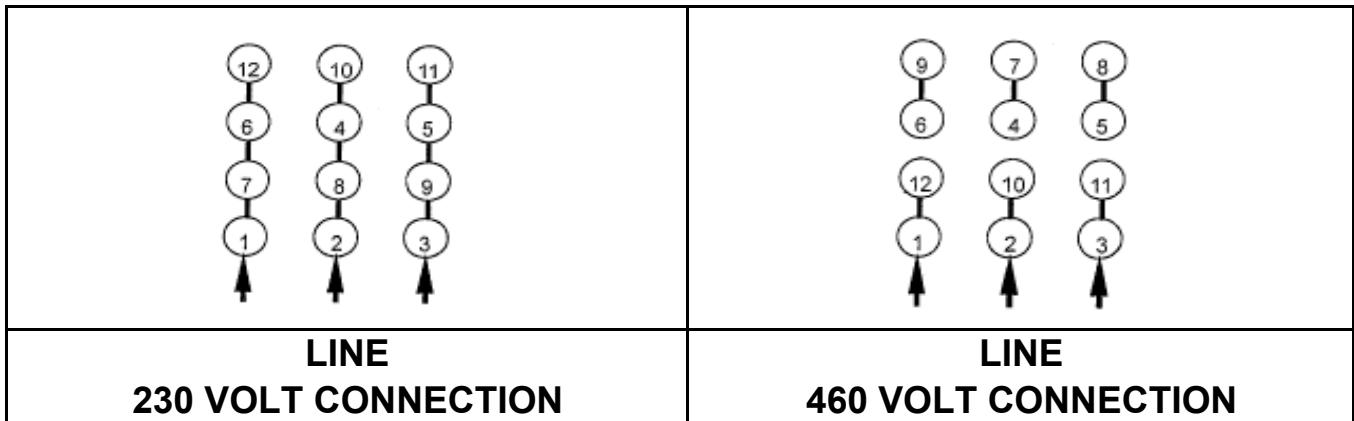

WYE START-DELTA RUN CONNECTION

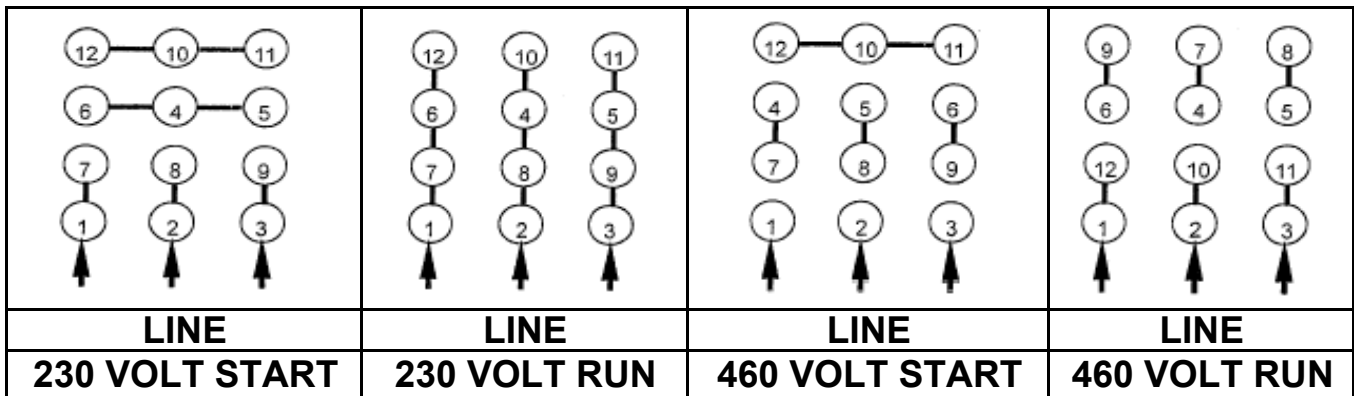

DWG NO.
DAC-1565-4