

DATE:  
September 13, 2006

# CONNECTION DIAGRAM

CATALOG NO.:  
EP0036C

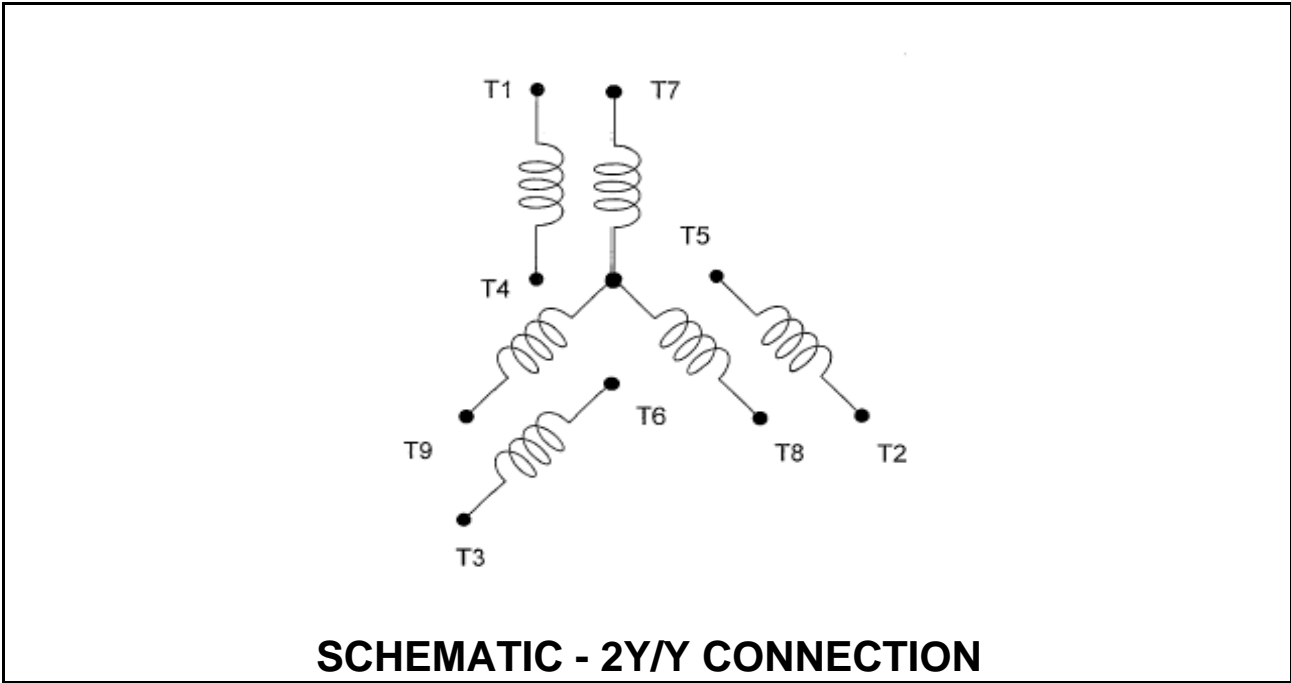

## ACROSS THE LINE CONNECTION

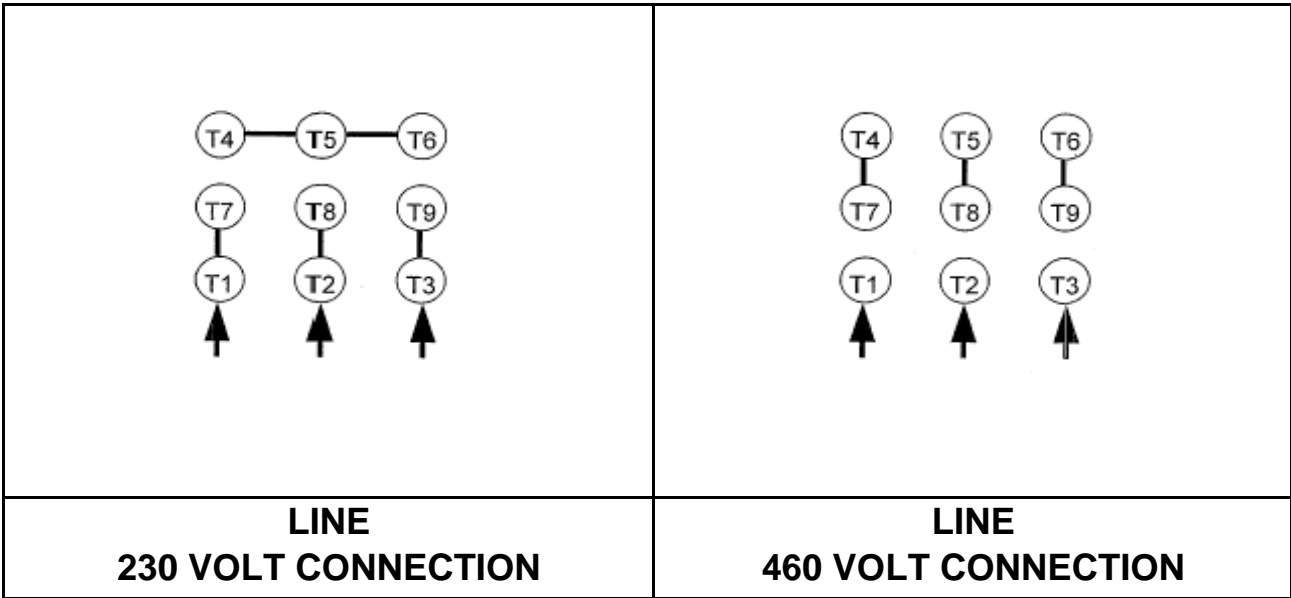

DWG NO.  
**DAC-1566-2**