

DATE:
September 13, 2006

CONNECTION DIAGRAM

CATALOG NO.:
EP0026C

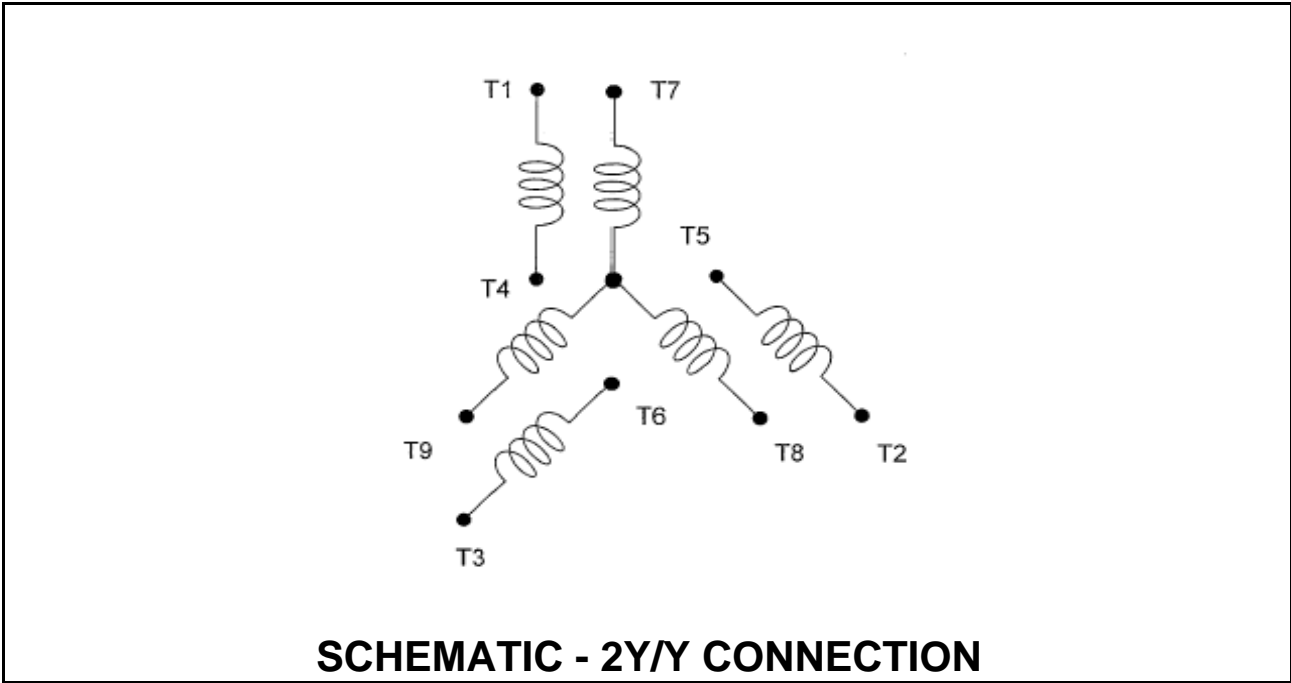

ACROSS THE LINE CONNECTION

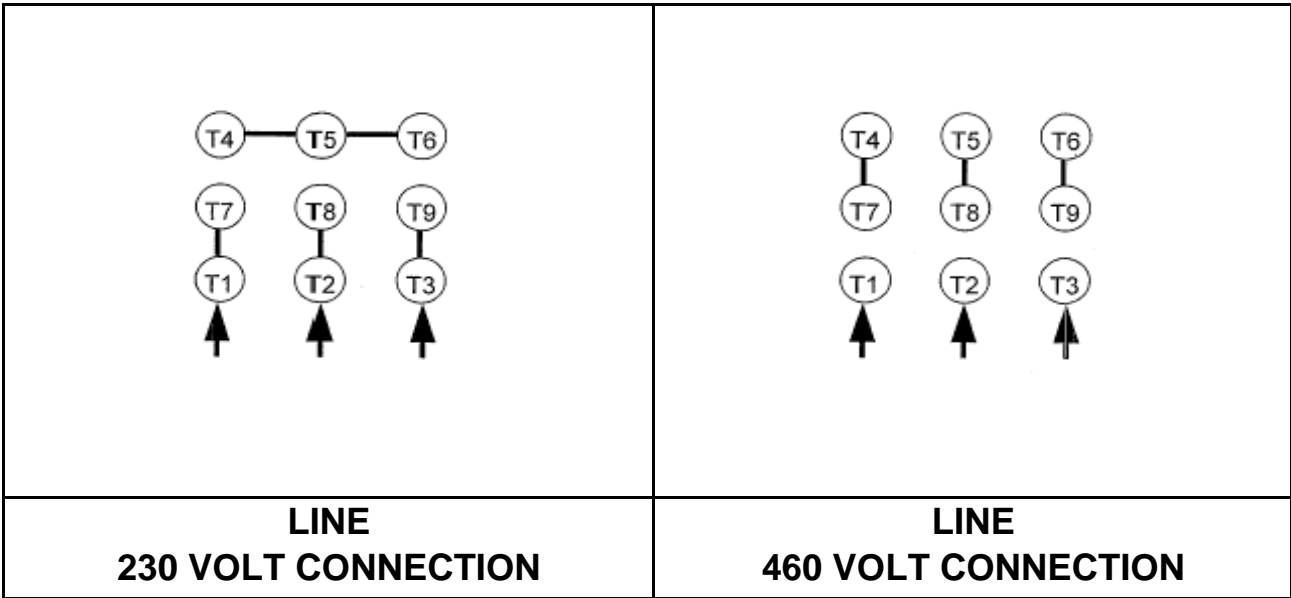

TECO  **Westinghouse**

DWG NO.
DAC-1566-2