

DATE:
August 19, 2015

CONNECTION DIAGRAM

CATALOG NO.:
DTP1/56G

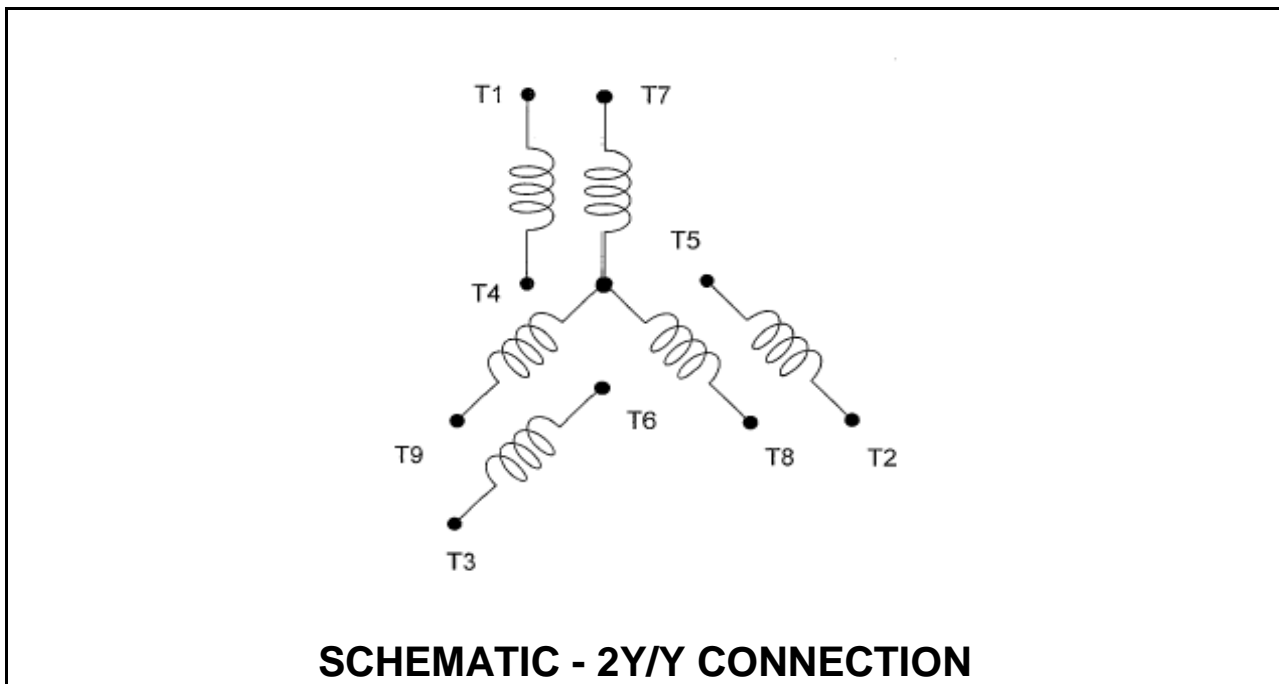

ACROSS THE LINE CONNECTION

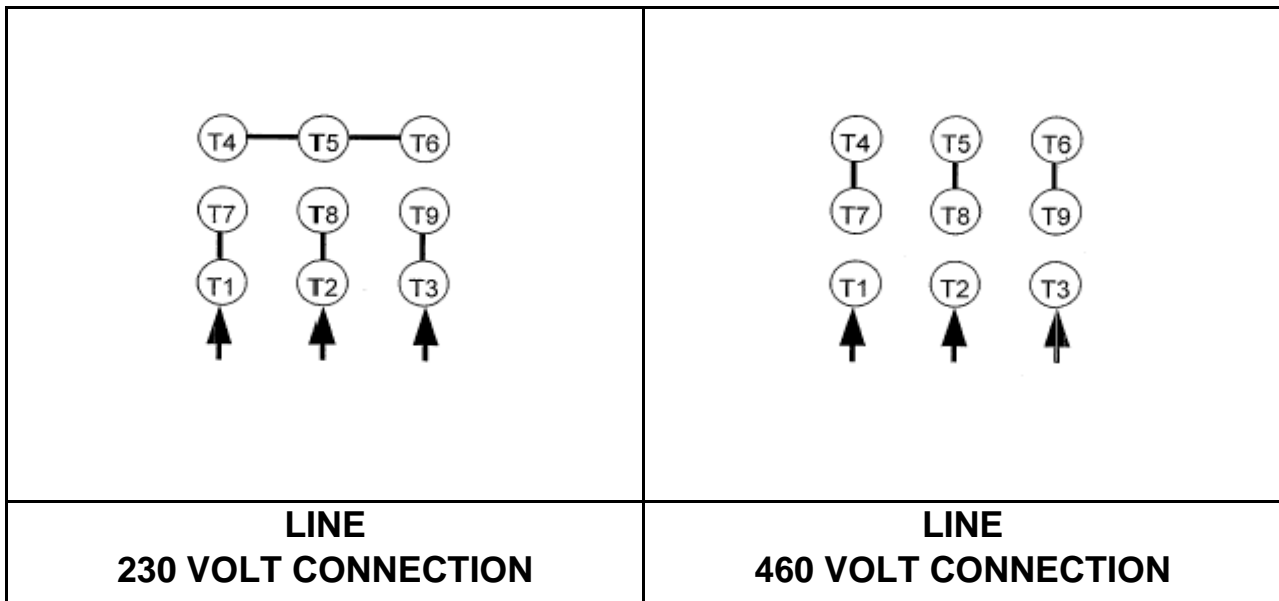

DWG NO.
DAC-1566-2