

| | | |
|---------------------------------|---------------------------|-----------------|
| DATE: August 19, 2015 | CONNECTION DIAGRAM | DTP0206G |
|---------------------------------|---------------------------|-----------------|

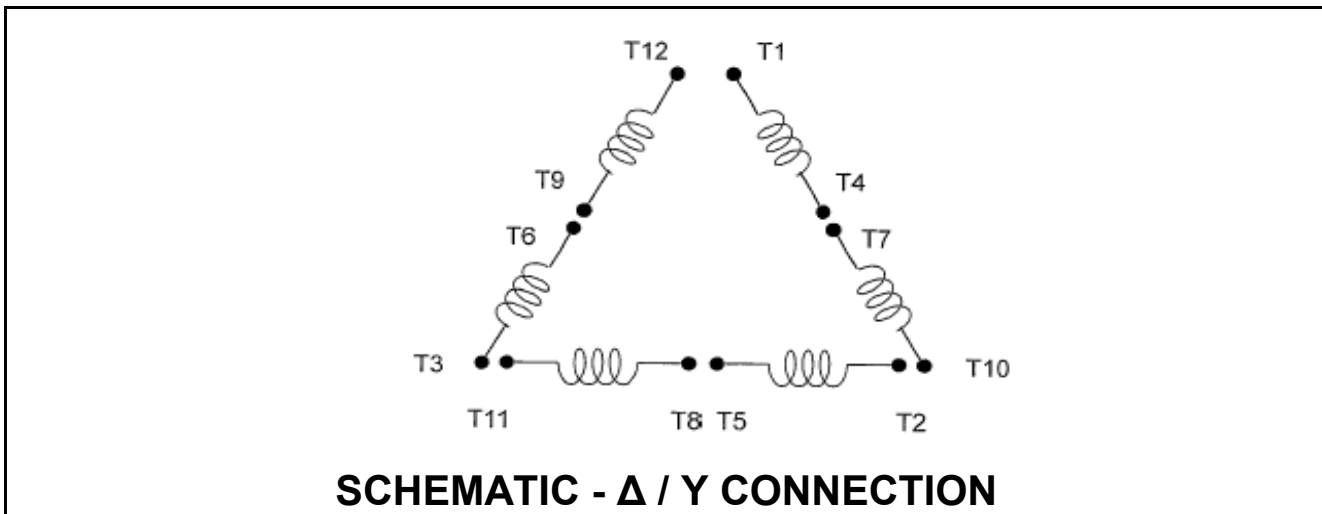

ACROSS THE LINE CONNECTION

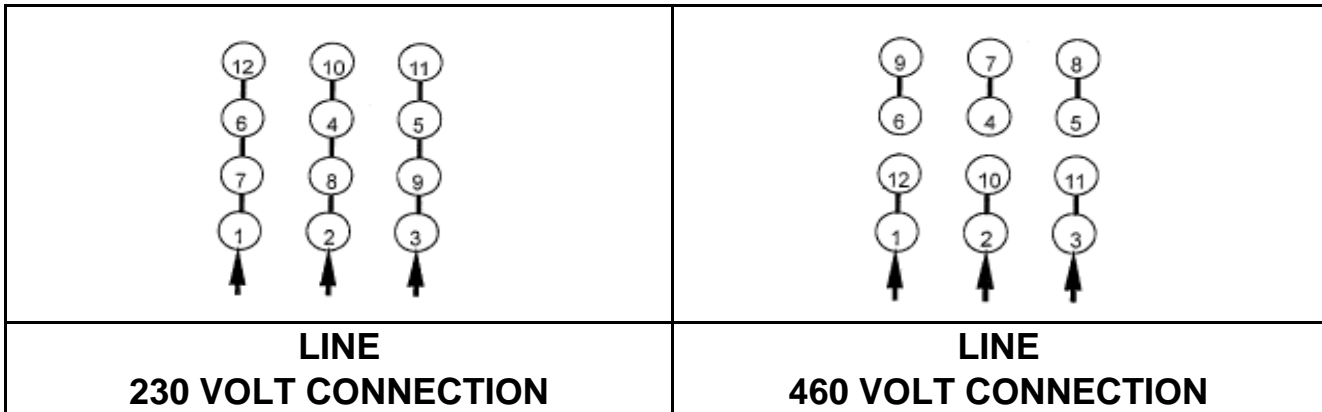

WYE START-DELTA RUN CONNECTION

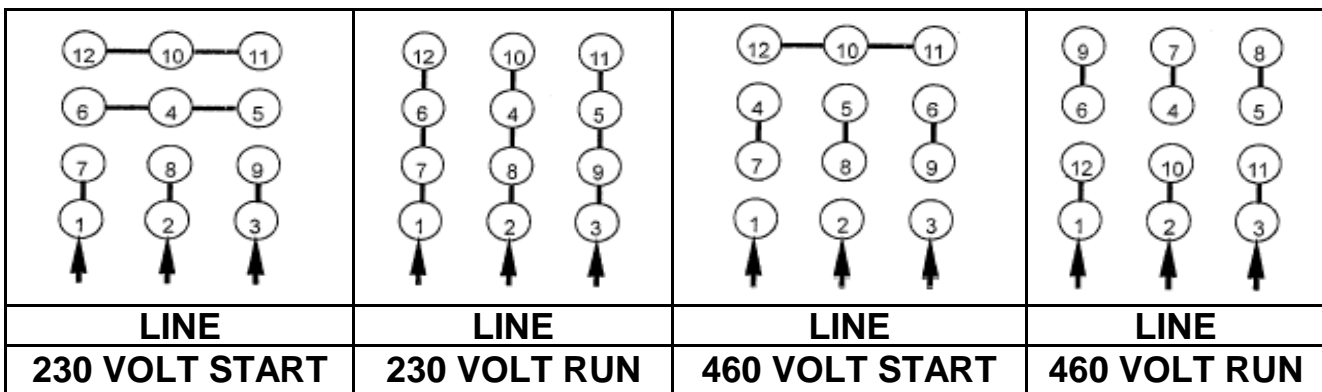

| | |
|--|------------------------------|
| | DWG NO. DAC-1565-4 |
|--|------------------------------|