

PE182T-3-2-575V

GENERAL PURPOSE ELECTRIC MOTOR

NEMA PREMIUM EFFICIENCY

TOTALLY ENCLOSED FAN COOLED

INVERTER DUTY 10:1 CT; 20:1 VT - NEMA MG1 PART 31

Factory Certified for T2B Class I, Division II, Groups A,B,C & D and Class II, Division II, Groups F & G

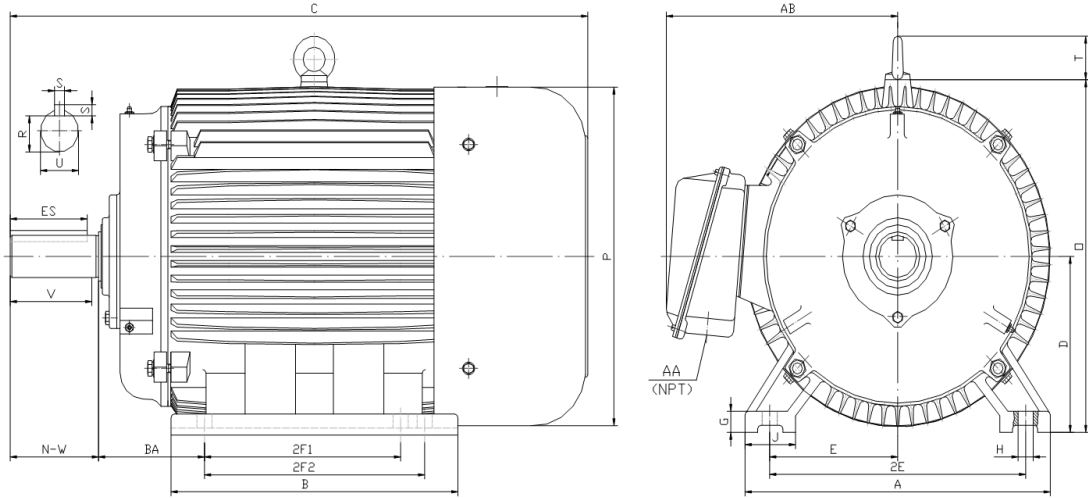

DIMENSIONS

HP	RPM	Frame	MOUNTING														
			A	B	C	D	G	H	J	E	2E	2F1	2F2	O	P	T	BA
3	3600	182T	9.50	7.30	16.10	4.50	0.60	0.41	2.00	3.75	7.50	4.50	5.50	9.10	8.70	1.60	2.75

Shaft Extension, Key Set						Conduit Box		Bearings		Mount
U	V	R	S	ES	N-W	AA	AB	DE	ODE	
1.13	2.50	0.99	0.25	1.78	2.75	0.75	7.50	6306-ZZ	6306-ZZ	F1

BEARING LUBRICATION: The bearings come lubricated with Mobil Polyrex EM Polyurea Grease.





PE182T-3-2-575V

GENERAL PURPOSE ELECTRIC MOTOR

NEMA PREMIUM EFFICIENCY

TOTALLY ENCLOSED FAN COOLED

INVERTER DUTY 10:1 CT; 20:1 VT - NEMA MG1 PART 31

Factory Certified for T2B Class I, Division II, Groups A,B,C & D and Class II, Division II, Groups F & G

PERFORMANCE DATA

HP	RPM	Frame	Voltage	Frequency (Hz)	Full Load S.F.	Insulation Class	NEMA Design	Slip (%)	NEMA Code	Enclosure Type	IP Rating	Max. Ambient
3	3520	182T	575	60	1.15	F	B	2.2	K	TEFC	55	40° C

Amps (575V)		Efficiency (%)				Power Factor			Torque (ft-lb)			DE Bearing	ODE Bearing	Connection	Weight (lbs.)
FLA	LRA	100%	75%	50%	Min.	100%	75%	50%	FLT	LRT %	BDT %				
3.0	26.0	86.5	85.5	83.0	84.0	0.850	0.790	0.680	4.5	180	280	6306-ZZ	6306-ZZ	3 Lead Y	90

NAME PLATE

				CONNECTION DIAGRAM 575 V Wye 			
INVERTER DUTY 20:1 VT; 10:1 CT							
CAT NO:	PE182T-3-2-575V	HP	3	Hz	60	PHASE	3
VOLTS	575	FLA	3.0	IP RATING	55		
RPM	3520	POWER FACTOR	0.85	DESIGN	B		
FRAME	182T	NEMA NOM EFF	86.5	CODE	K		
DRIVE END BEARING	6306-ZZ	NEMA MIN EFF	84.0	S.F.	1.15		
OPP DRIVE END BEARING	6306-ZZ	MAX AMB	40° C	INS CLASS	F		
ENCL	TEFC	RATING	CONT	SER			
MOTOR WEIGHT	90 LBS	CONNECTION	3 Lead Y	LUB:	Mobil Polyrex EM		
General purpose use on industrial machinery installed in damp, dusty or dirty environments. Hernando, Mississippi							CC 082A

APPLICATIONS:

General purpose use on pumps, fans, blowers, compressors, conveyors, material handling and other industrial machinery installed in damp, dusty or dirty environments.