

## PE145TC-2-4

GENERAL PURPOSE ELECTRIC MOTOR

NEMA PREMIUM EFFICIENCY

THREE PHASE, TOTALLY ENCLOSED FAN COOLED - C-FLANGE W/ FEET

INVERTER DUTY 10:1 CT; 20:1 VT - NEMA MG1 PART 31

Factory Certified for T2B Class I, Division II, Groups A,B,C & D and Class II, Division II, Groups F & G

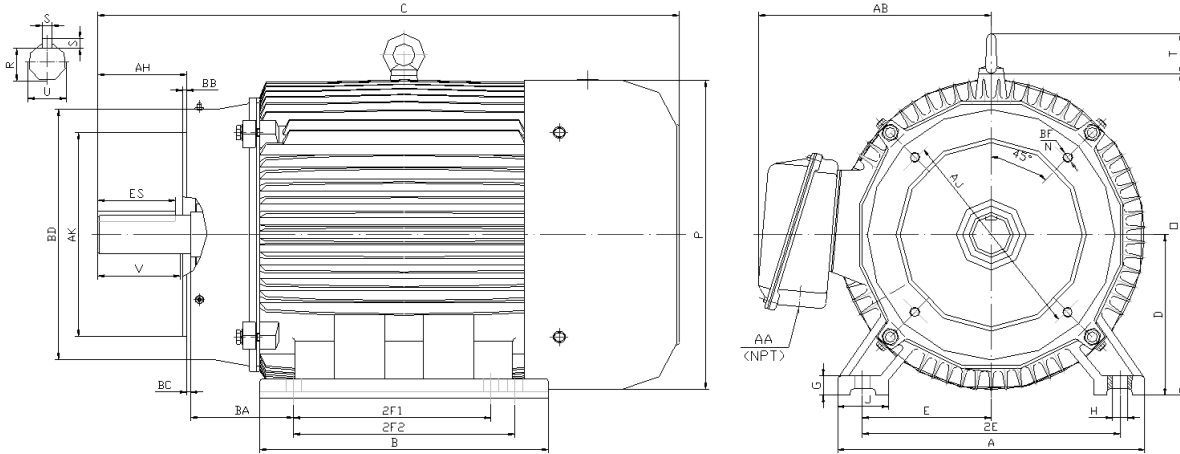

### DIMENSIONS

HP	RPM	Frame	MOUNTING														
			A	B	C	D	G	H	J	E	2E	2F1	2F2	O	P	T	BA
2	1800	145TC	7.00	7.20	14.60	3.50	0.50	0.34	1.40	2.75	5.50	4.00	5.00	7.10	6.95	0.00	2.25

FLANGE							Shaft Extension, Key Set						Conduit Box		Bearings		Mount
AH	AJ	AK	BB	BC	BD	BF	U	V	R	S	ES	N-W	AA	AB	DE	ODE	
2.12	5.88	4.50	0.16	0.12	6.50	4*3/8-16	0.88	2.00	0.77	0.19	1.41	NA	0.75	6.10	6205-ZZ	6205-ZZ	F1

**BEARING LUBRICATION:** The bearings come lubricated with Mobil Polyrex EM Polyurea Grease.





## PE145TC-2-4

**GENERAL PURPOSE ELECTRIC MOTOR**

**NEMA PREMIUM EFFICIENCY**

**THREE PHASE, TOTALLY ENCLOSED FAN COOLED - C-FLANGE W/ FEET**

**INVERTER DUTY 10:1 CT; 20:1 VT - NEMA MG1 PART 31**







Factory Certified for T2B Class I, Division II, Groups A,B,C & D and Class II, Division II, Groups F & G

### PERFORMANCE DATA

HP	RPM	Frame	Voltage	Frequency (Hz)	Full Load S.F.	Insulation Class	NEMA Design	Slip (%)	NEMA Code	Enclosure Type	IP Rating	Max. Ambient
2	1745	145TC	208-230/460	60	1.15	F	B	3.1	L	TEFC	55	40° C

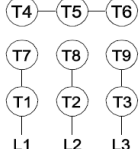
Amps (460V)		Efficiency (%)				Power Factor			Torque (ft-lb)			DE Bearing	ODE Bearing	Connection	Weight (lbs.)
FLA	LRA	100%	75%	50%	Min.	100%	75%	50%	FLT	LRT %	BDT %				
3.1	25.0	86.5	86.5	84.5	84.0	0.720	0.650	0.520	6.1	235	280	6205-ZZ	6205-ZZ	9 Lead 2Y/Y	56

### NAME PLATE

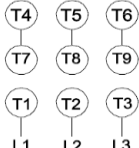
 <b>North American Electric, Inc.</b>													<b>CONNECTION DIAGRAMS</b>  <b>208-230V</b> 										
<b>INVERTER DUTY 20:1 VT; 10:1 CT</b>																							
CAT NO:		PE145TC-2-4				FRAME		145TC		PHASE		3											
HZ		60		S.F.		1.15		HZ		50		S.F.					1.0		ENCL		TEFC		IP
HP		2		RPM		1745		HP		2		RPM		1415		DUTY		CONT		DES		B	
VOLTS		208-230/460				VOLTS		190/380		AMB		40° C		INS		F							
FLA		6.6 - 6.2 / 3.1				FLA		7.0/3.5		DE BEARING		6205-ZZ											
CODE		L		P.F.		0.72		CODE		G		P.F.		0.79		ODE BEARING		6205-ZZ					
EFF		86.5		MIN		84.0		EFF		84		MIN		81.5		LUB:		Mobil Polyrex EM					
MOTOR WEIGHT		56		LBS		CONNECTION		9 Lead 2Y/Y		SER NO													
General purpose use on industrial machinery installed in damp, dusty or dirty environments.  Hernando, Mississippi																CC 082A		<b>460V</b> 					

### APPLICATIONS:

General purpose use on pumps, fans, blowers, compressors, conveyors, material handling and other industrial machinery installed in damp, dusty or dirty environments.