

**PE145T-2-4-575V**

**GENERAL PURPOSE ELECTRIC MOTOR**

**NEMA PREMIUM EFFICIENCY**

**TOTALLY ENCLOSED FAN COOLED**

**INVERTER DUTY 10:1 CT; 20:1 VT - NEMA MG1 PART 31**

Factory Certified for T2B Class I, Division II, Groups A,B,C & D and Class II, Division II, Groups F & G

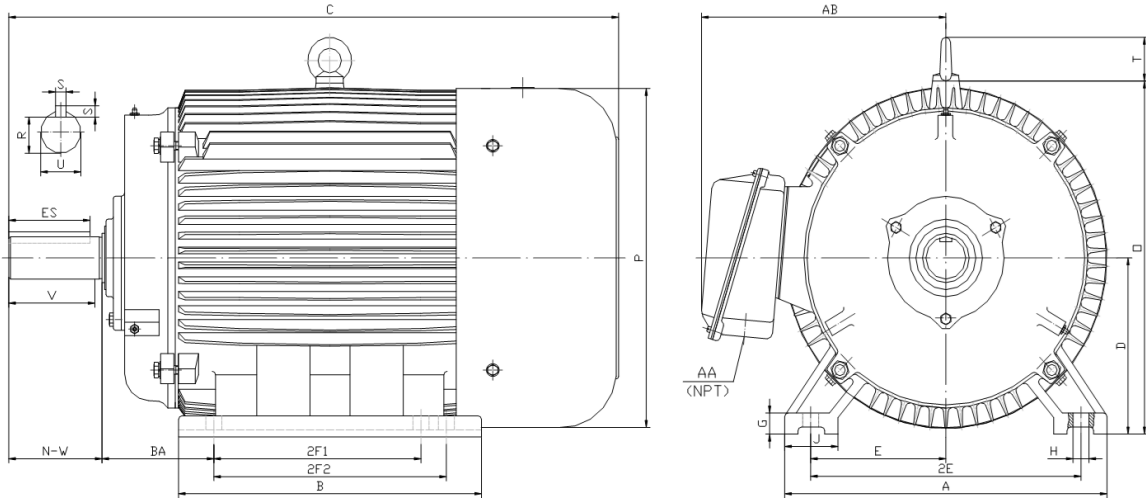

**DIMENSIONS**

HP	RPM	Frame	MOUNTING														
			A	B	C	D	G	H	J	E	2E	2F1	2F2	O	P	T	BA
2	1800	145T	7.00	7.20	14.60	3.50	0.50	0.34	1.40	2.75	5.50	4.00	5.00	7.10	6.95	0.00	2.25

Shaft Extension, Key Set						Conduit Box		Bearings		Mount
U	V	R	S	ES	N-W	AA	AB	DE	ODE	
0.88	2.00	0.77	0.19	1.41	2.25	0.75	6.10	6205-ZZ	6205-ZZ	F1

**BEARING LUBRICATION:** The bearings come lubricated with Mobil Polyrex EM Polyurea Grease.





## PE145T-2-4-575V

**GENERAL PURPOSE ELECTRIC MOTOR**

**NEMA PREMIUM EFFICIENCY**

**TOTALLY ENCLOSED FAN COOLED**

**INVERTER DUTY 10:1 CT; 20:1 VT - NEMA MG1 PART 31**







Factory Certified for T2B Class I, Division II, Groups A,B,C & D and Class II, Division II, Groups F & G

### PERFORMANCE DATA

HP	RPM	Frame	Voltage	Frequency (Hz)	Full Load S.F.	Insulation Class	NEMA Design	Slip (%)	NEMA Code	Enclosure Type	IP Rating	Max. Ambient
2	1745	145T	575	60	1.15	F	B	3.1	L	TEFC	55	40° C

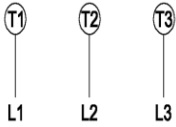
Amps (575V)		Efficiency (%)				Power Factor			Torque (ft-lb)			DE Bearing	ODE Bearing	Connection	Weight (lbs.)
FLA	LRA	100%	75%	50%	Min.	100%	75%	50%	FLT	LRT %	BDT %				
2.5	20.0	86.5	86.5	84.5	84.0	0.720	0.650	0.520	6.1	235	280	6205-ZZ	6205-ZZ	3 Lead Y	57

### NAME PLATE

 <b>North American Electric, Inc.</b>													<b>CONNECTION DIAGRAM</b>  575 V Wye 				
INVERTER DUTY 20:1 VT; 10:1 CT																	
CAT NO:		PE145T-2-4-575V			HP	2		Hz	60		PHASE	3					
VOLTS			575		FLA	2.5			IP RATING		55						
RPM		1745		POWER FACTOR			0.72		DESIGN		B						
FRAME		145T		NEMA NOM EFF			86.5		CODE		L						
DRIVE END BEARING		6205-ZZ		NEMA MIN EFF			84.0		S.F.		1.15						
OPP DRIVE END BEARING		6205-ZZ		MAX AMB			40° C		INS CLASS		F						
ENCL		TEFC		RATING	CONT		SER										
MOTOR WEIGHT		57 LBS		CONNECTION			3 Lead Y		LUB:		Mobil Polyrex EM						
General purpose use on industrial machinery installed in damp, dusty or dirty environments. Hernando, Mississippi																CC 082A	

### APPLICATIONS:

General purpose use on pumps, fans, blowers, compressors, conveyors, material handling and other industrial machinery installed in damp, dusty or dirty environments.