

PE145T-1.5-4C

CRUSHER DUTY ELECTRIC MOTOR

NEMA PREMIUM EFFICIENCY

TOTALLY ENCLOSED FAN COOLED

INVERTER DUTY 10:1 CT; 20:1 VT - NEMA MG1 PART 31

Factory Certified for T2B Class I, Division II, Groups A,B,C & D and Class II, Division II, Groups F & G

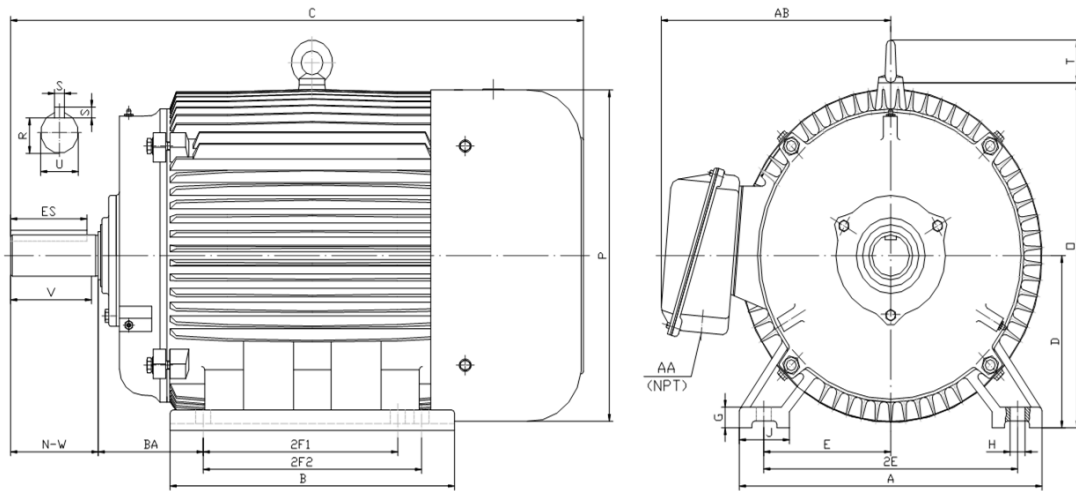

DIMENSIONS

HP	RPM	Frame	MOUNTING														
			A	B	C	D	G	H	J	E	2E	2F1	2F2	O	P	T	BA
1.5	1800	145T	7.00	6.20	14.60	3.50	0.50	0.34	1.40	2.75	5.50	4.00	5.00	7.10	6.95	0.00	2.25

Shaft Extension, Key Set						Conduit Box		Bearings		Mount
U	V	R	S	ES	N-W	AA	AB	DE	ODE	
0.875	2.00	0.771	0.188	1.41	2.25	0.75	6.10	6205-ZZ	6205-ZZ	F1

BEARING LUBRICATION: The bearings come lubricated with Mobil Polyrex EM Polyurea Grease.





PE145T-1.5-4C

CRUSHER DUTY ELECTRIC MOTOR

NEMA PREMIUM EFFICIENCY

TOTALLY ENCLOSED FAN COOLED

INVERTER DUTY 10:1 CT; 20:1 VT - NEMA MG1 PART 31







Factory Certified for T2B Class I, Division II, Groups A,B,C & D and Class II, Division II, Groups F & G

PERFORMANCE DATA

HP	RPM	Frame	Voltage	Frequency (Hz)	Full Load S.F.	Insulation Class	NEMA Design	Slip (%)	NEMA Code	Enclosure Type	IP Rating	Max. Ambient
1.5	1750	145T	208-230/460	60	1.15	F	C	2.8	M	TEFC	55	40° C

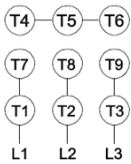
Amps (460V)		Efficiency (%)				Power Factor			Torque (ft-lb)			DE Bearing	ODE Bearing	Connection	Weight (lbs.)
FLA	LRA	100%	75%	50%	Min.	100%	75%	50%	FLT	LRT%	BDT%				
2.2	20	86.5	86.0	83.5	84.0	0.700	0.620	0.480	4.5	290	330	6205-ZZ	6205-ZZ	9 Lead 2Y/Y	50

NAME PLATE

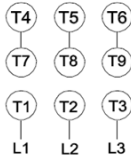
 										CONNECTION DIAGRAMS 208-230V 		
CAT NO:		PE145T-1.5-4C			FRAME		145T		PHASE			
HZ	60	S.F.	1.15	HZ	50	S.F.	1.0	ENCL	TEFC	IP	55	
HP	1.5	RPM	1750	HP	1.5	RPM	1430	DUTY	CONT	DES	C	
VOLTS		208-230/460			VOLTS		190/380		AMB	40° C	INS	F
FLA	4.7 - 4.4 / 2.2			FLA		5.4/2.7		DE BEARING		6205-ZZ		
CODE	M	P.F.	0.70	CODE	H	P.F.	0.75	ODE BEARING		6205-ZZ		
EFF	86.5	MIN	84.0	EFF	84	MIN	81.5	LUB:		Mobil Polyrex EM		
MOTOR WEIGHT		50	LBS	CONNECTION		9 Lead 2Y/Y		SER NO				
General purpose use on industrial machinery installed in damp, dusty or dirty environments. Hernando, Mississippi										   CC 082A		
										460V 		

APPLICATIONS:

General purpose use on pumps, fans, blowers, compressors, conveyors, material handling and other industrial machinery installed in damp, dusty or dirty environments.