

PE145T-1-6-575V

GENERAL PURPOSE ELECTRIC MOTOR

NEMA PREMIUM EFFICIENCY

TOTALLY ENCLOSED FAN COOLED

INVERTER DUTY 10:1 CT; 20:1 VT - NEMA MG1 PART 31

Factory Certified for T2B Class I, Division II, Groups A,B,C & D and Class II, Division II, Groups F & G

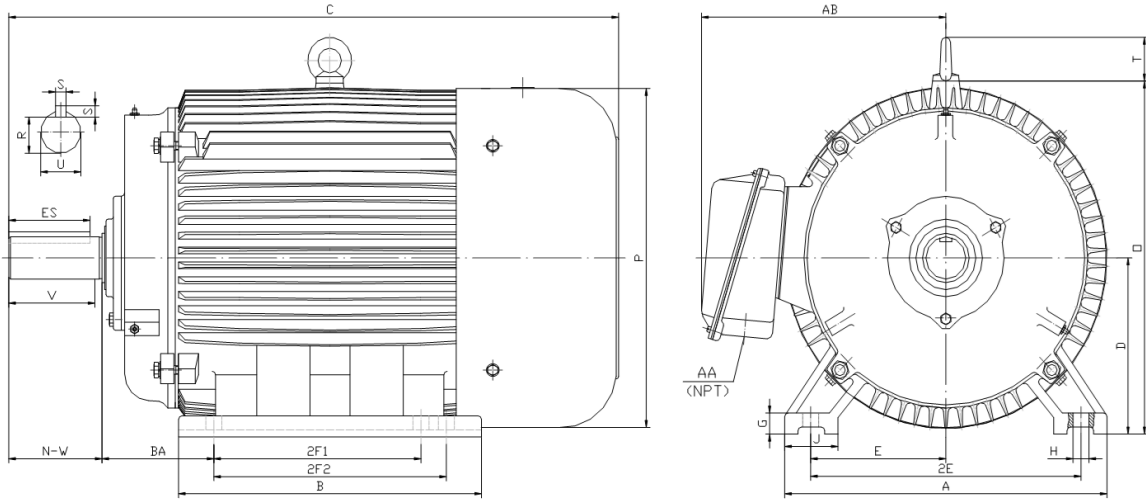

DIMENSIONS

HP	RPM	Frame	MOUNTING														
			A	B	C	D	G	H	J	E	2E	2F1	2F2	O	P	T	BA
1	1200	145T	7.00	7.20	14.60	3.50	0.50	0.34	1.40	2.75	5.50	4.00	5.00	7.10	6.95	0.00	2.25

Shaft Extension, Key Set						Conduit Box		Bearings		Mount
U	V	R	S	ES	N-W	AA	AB	DE	ODE	
0.88	2.00	0.77	0.19	1.41	2.25	0.75	6.10	6205-ZZ	6205-ZZ	F1

BEARING LUBRICATION: The bearings come lubricated with Mobil Polyrex EM Polyurea Grease.





PE145T-1-6-575V

GENERAL PURPOSE ELECTRIC MOTOR

NEMA PREMIUM EFFICIENCY

TOTALLY ENCLOSED FAN COOLED

INVERTER DUTY 10:1 CT; 20:1 VT - NEMA MG1 PART 31







Factory Certified for T2B Class I, Division II, Groups A,B,C & D and Class II, Division II, Groups F & G

PERFORMANCE DATA

HP	RPM	Frame	Voltage	Frequency (Hz)	Full Load S.F.	Insulation Class	NEMA Design	Slip (%)	NEMA Code	Enclosure Type	IP Rating	Max. Ambient
1	1160	145T	575	60	1.15	F	B	3.3	M	TEFC	55	40° C

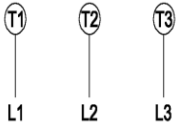
Amps (575V)		Efficiency (%)				Power Factor			Torque (ft-lb)			DE Bearing	ODE Bearing	Connection	Weight (lbs.)
FLA	LRA	100%	75%	50%	Min.	100%	75%	50%	FLT	LRT %	BDT %				
1.4	12.0	82.5	81.0	79.0	80.0	0.620	0.540	0.430	4.6	200	290	6205-ZZ	6205-ZZ	3 Lead Y	52

NAME PLATE

 North American Electric, Inc.													CONNECTION DIAGRAM 575 V Wye 				
INVERTER DUTY 20:1 VT; 10:1 CT																	
CAT NO:		PE145T-1-6-575V			HP	1		Hz	60		PHASE	3					
VOLTS			575		FLA	1.4			IP RATING		55						
RPM		1160			POWER FACTOR			0.62		DESIGN		B					
FRAME		145T			NEMA NOM EFF			82.5		CODE		M					
DRIVE END BEARING		6205-ZZ			NEMA MIN EFF			80.0		S.F.		1.15					
OPP DRIVE END BEARING		6205-ZZ			MAX AMB			40° C		INS CLASS		F					
ENCL		TEFC			RATING	CONT		SER									
MOTOR WEIGHT		52 LBS		CONNECTION			3 Lead Y		LUB: Mobil Polyrex EM								
General purpose use on industrial machinery installed in damp, dusty or dirty environments. Hernando, Mississippi																CC 082A	

APPLICATIONS:

General purpose use on pumps, fans, blowers, compressors, conveyors, material handling and other industrial machinery installed in damp, dusty or dirty environments.