

PE143TC-1.5-2

GENERAL PURPOSE ELECTRIC MOTOR

NEMA PREMIUM EFFICIENCY

THREE PHASE, TOTALLY ENCLOSED FAN COOLED - C-FLANGE W/ FEET

INVERTER DUTY 10:1 CT; 20:1 VT - NEMA MG1 PART 31

Factory Certified for T2B Class I, Division II, Groups A,B,C & D and Class II, Division II, Groups F & G

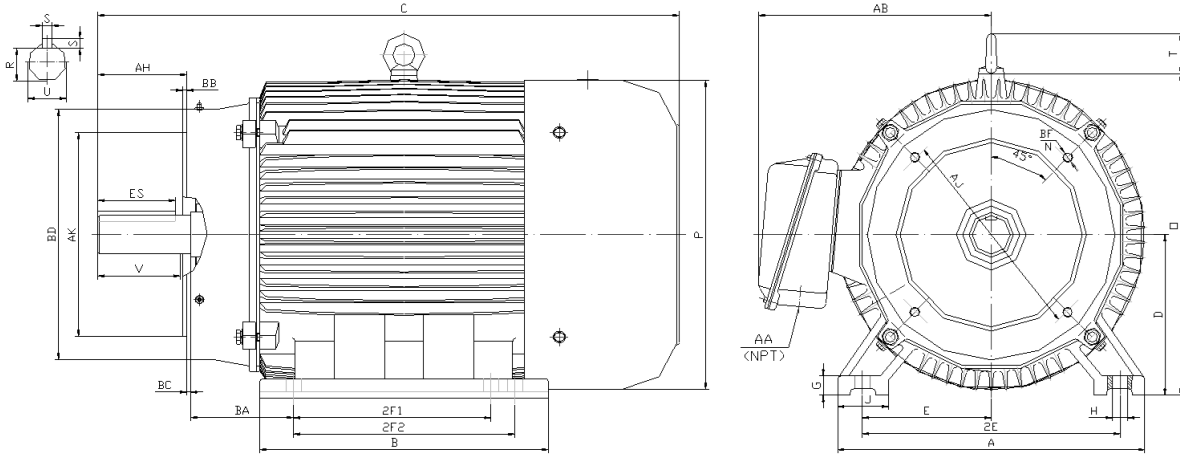

DIMENSIONS

HP	RPM	Frame	MOUNTING														
			A	B	C	D	G	H	J	E	2E	2F1	2F2	O	P	T	BA
1.5	3600	143TC	7.00	6.20	13.60	3.50	0.50	0.34	1.40	2.75	5.50	4.00	5.00	7.10	6.95	0.00	2.25

FLANGE							Shaft Extension, Key Set						Conduit Box		Bearings		Mount
AH	AJ	AK	BB	BC	BD	BF	U	V	R	S	ES	N-W	AA	AB	DE	ODE	
2.12	5.88	4.50	0.16	0.12	6.50	4*3/8-16	0.88	2.00	0.77	0.19	1.41	NA	0.75	6.10	6205-ZZ	6205-ZZ	F1

BEARING LUBRICATION: The bearings come lubricated with Mobil Polyrex EM Polyurea Grease.





PE143TC-1.5-2

GENERAL PURPOSE ELECTRIC MOTOR

NEMA PREMIUM EFFICIENCY

THREE PHASE, TOTALLY ENCLOSED FAN COOLED - C-FLANGE W/ FEET

INVERTER DUTY 10:1 CT; 20:1 VT - NEMA MG1 PART 31







Factory Certified for T2B Class I, Division II, Groups A,B,C & D and Class II, Division II, Groups F & G

PERFORMANCE DATA

HP	RPM	Frame	Voltage	Frequency (Hz)	Full Load S.F.	Insulation Class	NEMA Design	Slip (%)	NEMA Code	Enclosure Type	IP Rating	Max. Ambient
1.5	3520	143TC	208-230/460	60	1.15	F	B	2.2	M	TEFC	55	40° C

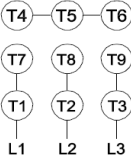
Amps (460V)		Efficiency (%)				Power Factor			Torque (ft-lb)			DE Bearing	ODE Bearing	Connection	Weight (lbs.)
FLA	LRA	100%	75%	50%	Min.	100%	75%	50%	FLT	LRT %	BDT %				
2.0	20.0	84.0	82.0	77.0	81.5	0.740	0.660	0.540	2.2	200	280	6205-ZZ	6205-ZZ	9 Lead 2Y/Y	46

NAME PLATE

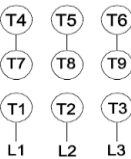
 North American Electric, Inc.													CONNECTION DIAGRAMS 208-230V 		
INVERTER DUTY 20:1 VT; 10:1 CT															
CAT NO: PE143TC-1.5-2			FRAME 143TC			PHASE 3									
HZ 60	S.F. 1.15	HZ 50	S.F. 1.0	ENCL TEFC	IP 55										
HP 1.5	RPM 3520	HP 1.5	RPM 2900	DUTY CONT	DES B										
VOLTS 208-230/460		VOLTS 190/380		AMB 40° C	INS F										
FLA 4.4 - 4 / 2		FLA 5.2/2.6		DE BEARING 6205-ZZ											
CODE M	P.F. 0.74	CODE K	P.F. 0.80	ODE BEARING 6205-ZZ											
EFF 84.0	MIN 81.5	EFF 82	MIN 79.5	LUB: Mobil Polyrex EM											
MOTOR WEIGHT 46 LBS		CONNECTION 9 Lead 2Y/Y		SER NO											
General purpose use on industrial machinery installed in damp, dusty or dirty environments. Hernando, Mississippi										   CC 082A					
										460V 					

APPLICATIONS:

General purpose use on pumps, fans, blowers, compressors, conveyors, material handling and other industrial machinery installed in damp, dusty or dirty environments.