

**PE143JM-1-4**

**CLOSE COUPLED PUMP MOTORS**

**NEMA PREMIUM EFFICIENCY**

**THREE PHASE, TOTALLY ENCLOSED FAN COOLED, JM FRAME**

**INVERTER DUTY 10:1 CT; 20:1 VT - NEMA MG1 PART 31**

Factory Certified for T2B Class I, Division II, Groups A,B,C & D and Class II, Division II, Groups F & G

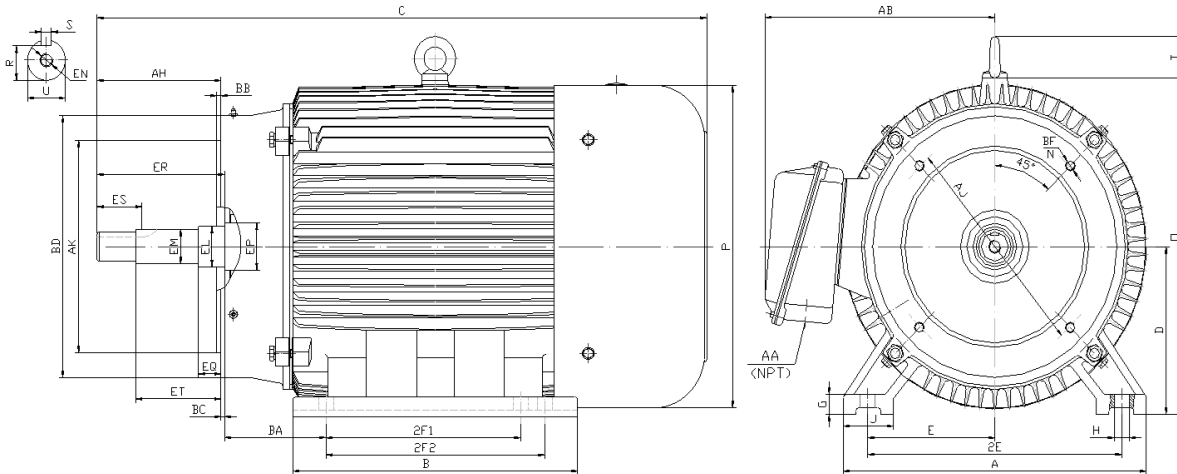

**DIMENSIONS**

HP	RPM	Frame	MOUNTING														
			A	B	C	D	G	H	J	E	2E	2F1	2F2	O	P	T	BA
1	1800	143JM	7.00	6.20	16.23	3.50	0.50	0.34	1.40	2.75	5.50	4.00	5.00	7.10	6.95	0.00	2.75

FLANGE							Shaft Extension, Key Set										
AK	AJ	AH	BB	BC	BD	N*BF	U	R	S	EQ	ER	ES	ET	EP	EL	EM	EN
4.500	5.88	4.281	0.156	0.12	6.62	4*3/8-16	0.8745	0.771	0.190	0.640	4.25	1.65	2.890	1.18	1.156	1.0000	3/8-16
4.497		4.219	0.125				0.8740	0.756	0.188	0.610			2.860		1.154	0.9995	

Conduit Box		Bearings		Mount
AA	AB	DE	ODE	
0.75	6.10	6206-ZZ	6205-ZZ	F1

**BEARING LUBRICATION:** The bearings come lubricated with Mobil Polyrex EM Polyurea Grease.





## PE143JM-1-4

**CLOSE COUPLED PUMP MOTORS**

**NEMA PREMIUM EFFICIENCY**

**THREE PHASE, TOTALLY ENCLOSED FAN COOLED, JM FRAME**

**INVERTER DUTY 10:1 CT; 20:1 VT - NEMA MG1 PART 31**







Factory Certified for T2B Class I, Division II, Groups A,B,C & D and Class II, Division II, Groups F & G

### PERFORMANCE DATA

HP	RPM	Frame	Voltage	Frequency (Hz)	Full Load S.F.	Insulation Class	NEMA Design	Slip (%)	NEMA Code	Enclosure Type	IP Rating	Max. Ambient
1	1745	143JM	208-230/460	60	1.15	F	B	3.1	M	TEFC	55	40° C

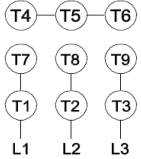
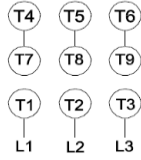
Amps (460V)		Efficiency (%)				Power Factor			Torque (ft-lb)			DE Bearing	ODE Bearing	Connection	Weight (lbs.)
FLA	LRA	100%	75%	50%	Min.	100%	75%	50%	FLT	LRT %	BDT %				
1.5	15.0	85.5	85.0	83.6	82.5	0.710	0.620	0.490	3.0	275	310	6206-ZZ	6205-ZZ	9 Lead 2Y/Y	45

### NAME PLATE

 <b>North American Electric, Inc.</b>													<b>CONNECTION DIAGRAMS</b>  <b>208-230V</b> 										
<b>INVERTER DUTY 20:1 VT; 10:1 CT</b>										<b>CLOSE COUPLED PUMP MOTOR</b>													
CAT NO:		PE143JM-1-4				FRAME		143JM		PHASE		3		<b>460V</b> 									
HZ		60		S.F.		1.15		HZ		50		S.F.					1.0		ENCL		TEFC		IP
HP		1		RPM		1745		HP		1		RPM		1430		DUTY		CONT		DES		B	
VOLTS		208-230/460				VOLTS		190/380		AMB		40° C		INS		F							
FLA		3.2 - 3 / 1.5				FLA		3.6/1.8		DE BEARING		6206-ZZ											
CODE		M		P.F.		0.71		CODE		H		P.F.		0.77		ODE BEARING		6205-ZZ					
EFF		85.5		MIN		82.5		EFF		83		MIN		80.0		LUB:		Mobil Polyrex EM					
MOTOR WEIGHT		45		LBS		CONNECTION		9 Lead 2Y/Y		SER NO													
Specifically designed for use on industrial and commercial pumping units.  Hernando, Mississippi																CC 082A							

### APPLICATIONS:

Specifically designed for use on industrial and commercial pumping units.