

OWP444T-75-8

OIL WELL PUMP MOTOR

HIGH TORQUE / HIGH SLIP (5 - 8%)

TOTALLY ENCLOSED FAN COOLED

INVERTER DUTY 10:1 CONSTANT TORQUE - NEMA MG1 PART 31

Factory Certified for T2B Class I, Division II, Groups A,B,C & D and Class II, Division II, Groups F & G

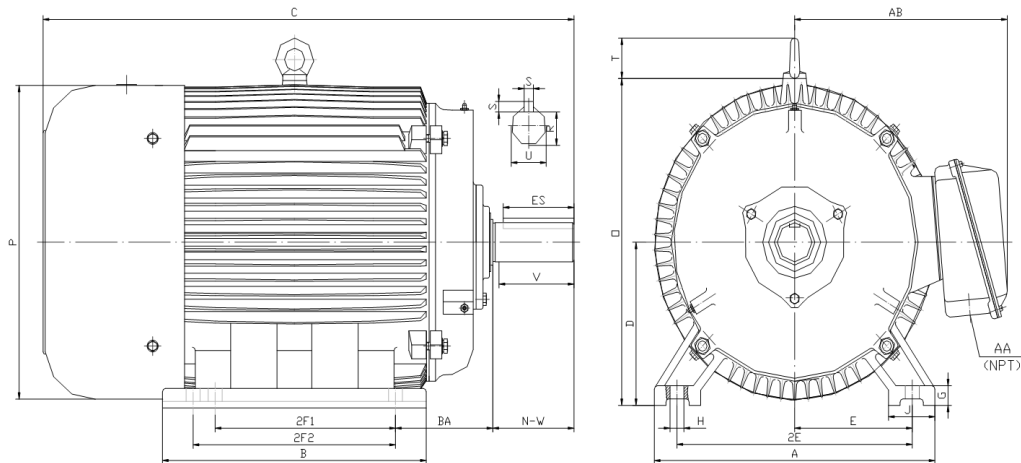

DIMENSIONS

HP	RPM	Frame	MOUNTING														
			A	B	C	D	G	H	J	E	2E	2F1	2F2	O	P	T	BA
75	855	444T	21.70	22.90	44.30	11.00	1.35	0.81	3.35	9.00	18.00	14.50	16.50	22.10	21.60	3.00	7.50

Shaft Extension, Key Set						Conduit Box		Bearings		Mount
U	V	R	S	ES	N-W	AA	AB	DE	ODE	
3.375	8.25	2.880	0.875	6.91	8.50	3.00	19.00	NU318	6317	F2

BEARING LUBRICATION: The bearings come lubricated with Mobil Polyrex EM Polyurea Grease. It is recommended that you add some additional lubrication when the motor is installed.

Three options (brands) for suitable lubrication include, but are not limited to, the following:

- 1.) Mobil Polyrex EM
- 2.) Citco Polyurea MP
- 3.) Conoco Phillips Polytac EP





OWP444T-75-8

OIL WELL PUMP MOTOR

HIGH TORQUE / HIGH SLIP (5 - 8%)

TOTALLY ENCLOSED FAN COOLED

INVERTER DUTY 10:1 CONSTANT TORQUE - NEMA MG1 PART 31

Factory Certified for T2B Class I, Division II, Groups A,B,C & D and Class II, Division II, Groups F & G

PERFORMANCE DATA

HP	RPM	Frame	Voltage	Frequency (Hz)	Full Load S.F.	Insulation Class	NEMA Design	Slip (%)	NEMA Code	Enclosure Type	IP Rating	Max. Ambient
75	855	444T	230/460/796	60	1.15	F	D	5.0	G	TEFC	55	40° C

Amps (460V)		Efficiency (%)				Power Factor			Torque (ft-lb)			DE Bearing	DE Bearing	Connection	Weight (lbs.)
FLA	LRA	100%	75%	50%	Min.	100%	75%	50%	FLT	LRT %	BDT %				
95.5	542.0	91.7	91.7	91.0	90.2	0.80	0.75	0.63	460.0	275	290	NU318	6317	12 Lead 2Δ/Δ/Y	1328

NAME PLATE

North American Electric, Inc. OIL WELL PUMP MOTOR						CONNECTION DIAGRAMS		
INVERTER DUTY 10:1 CONSTANT TORQUE						NEMA DESIGN D HIGH TORQUE/HIGH SLIP (5-8%)		
CAT NO: OWP444T-75-8		HP	75	Hz	60	PHASE	3	
VOLTS 230/460/796		FLA 95.5		IP RATING		55		
RPM	855	POWER FACTOR		0.80		DESIGN		D
FRAME	444T	NEMA NOM EFF		91.7		CODE		G
DRIVE END BEARING	NU318	NEMA MIN EFF		90.2		S.F.		1.15
OPP DRIVE END BEARING	6317	MAX AMB		40° C		INS CLASS		F
ENCL	TEFC	RATING	CONT	SER				
MOTOR WEIGHT	1328 LBS	CONNECTION		12 Lead 2Δ/Δ/Y		LUB:		Mobil Polyrex EM
Designed Specifically for use on Oil Well Pumping Units Hernando, Mississippi						CC 082A		
						230V 		
						460V 		
						796V 		

APPLICATIONS:

Designed Specifically for use on Oil Well Pumping Units. Suitable for use on Variable Frequency Drives (VFDs).