

OWP405T-60-6-ODP

OIL WELL PUMP MOTOR

HIGH TORQUE / HIGH SLIP (5 - 8%)

OPEN DRIP PROOF

INVERTER DUTY 10:1 CONSTANT TORQUE - MEETS NEMA MG1 PART 31

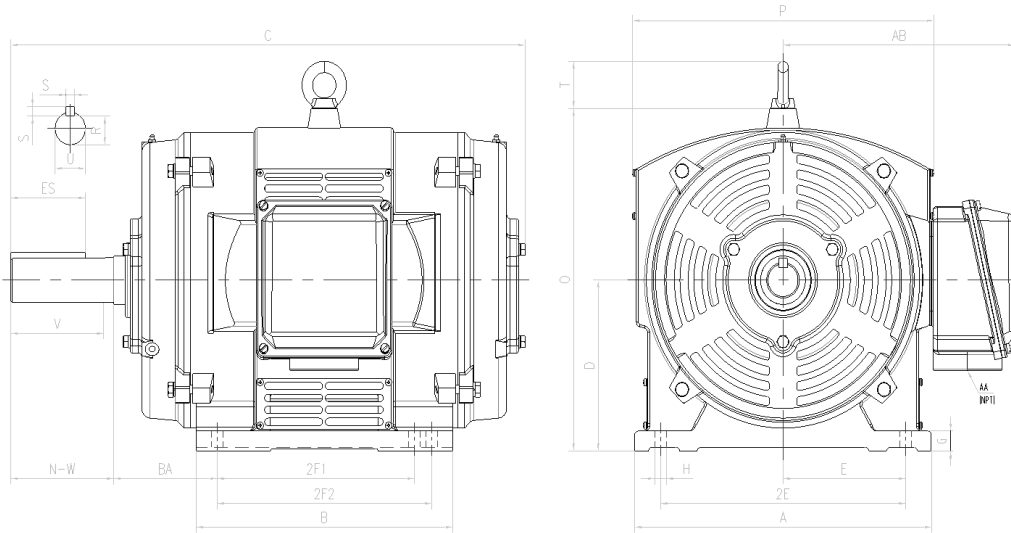

DIMENSIONS

HP	RPM	Frame	MOUNTING														
			A	B	C	D	G	H	J	E	2E	2F1	2F2	O	P	T	BA
60	1200	405T	19.10	17.00	33.30	10.00	1.15	0.81	N/A	8.00	16.00	12.25	13.75	21.00	20.25	2.60	6.62

Shaft Extension, Key Set						Conduit Box		Bearings		Mount
U	V	R	S	ES	N-W	AA	AB	DE	ODE	
2.875	7.00	2.450	0.750	5.65	7.25	3.00	14.50	NU318	6314	F2

BEARING LUBRICATION: The bearings come lubricated with Mobil Polyrex EM Polyurea Grease. It is recommended that you add some additional lubrication when the motor is installed.

Three options (brands) for suitable lubrication include, but are not limited to, the following:

- 1.) Mobil Polyrex EM
- 2.) Citco Polyurea MP
- 3.) Conoco Phillips Polytac EP





OWP405T-60-6-ODP

OIL WELL PUMP MOTOR

HIGH TORQUE / HIGH SLIP (5 - 8%)

OPEN DRIP PROOF

INVERTER DUTY 10:1 CONSTANT TORQUE - MEETS NEMA MG1 PART 31

PERFORMANCE DATA

HP	RPM	Frame	Voltage	Frequency (Hz)	Full Load S.F.	Insulation Class	NEMA Design	Slip (%)	NEMA Code	Enclosure Type	IP Rating	Max. Ambient
60	1140	405T	230/460/796	60	1.15	F	D	5.0	G	ODP	23	40° C

Amps (460V)		Efficiency (%)				Power Factor			Torque (ft-lb)			DE Bearing	ODE Bearing	Connection	Weight (lbs.)
FLA	LRA	100%	75%	50%	Min.	100%	75%	50%	FLT	LRT %	BDT %	NU318	6314	12 Lead 2Δ/Δ/Y	911
76.0	435.0	88.5	89.0	89.0	86.5	0.84	0.80	0.69	277.0	275	300				

NAME PLATE

North American Electric, Inc.						OIL WELL PUMP MOTOR						CONNECTION DIAGRAMS									
INVERTER DUTY 10:1 CONSTANT TORQUE						NEMA DESIGN D HIGH TORQUE/HIGH SLIP (5-8%)															
CAT NO:		OWP405T-60-6-ODP		HP		60		Hz		60		PHASE		3							
VOLTS		230/460/796		FLA		76.0		IP RATING		23											
RPM		1140		POWER FACTOR		0.84		DESIGN		D											
FRAME		405T		NEMA NOM EFF		88.5		CODE		G											
DRIVE END BEARING		NU318		NEMA MIN EFF		86.5		S.F.		1.15											
OPP DRIVE END BEARING		6314		MAX AMB		40° C		INS CLASS		F											
ENCL		ODP		RATING		CONT		SER													
MOTOR WEIGHT		911 LBS		CONNECTION		12 Lead 2Δ/Δ/Y		LUB:		Mobil Polyrex EM											
Designed Specifically for use on Oil Well Pumping Units Hernando, Mississippi												CC 082A									

APPLICATIONS:

Designed Specifically for use on Oil Well Pumping Units. Suitable for use on Variable Frequency Drives (VFDs).