

## OWP365T-40-8

OIL WELL PUMP MOTOR

HIGH TORQUE / HIGH SLIP (5 - 8%)

TOTALLY ENCLOSED FAN COOLED

INVERTER DUTY 10:1 CONSTANT TORQUE - NEMA MG1 PART 31

Factory Certified for T2B Class I, Division II, Groups A,B,C & D and Class II, Division II, Groups F & G

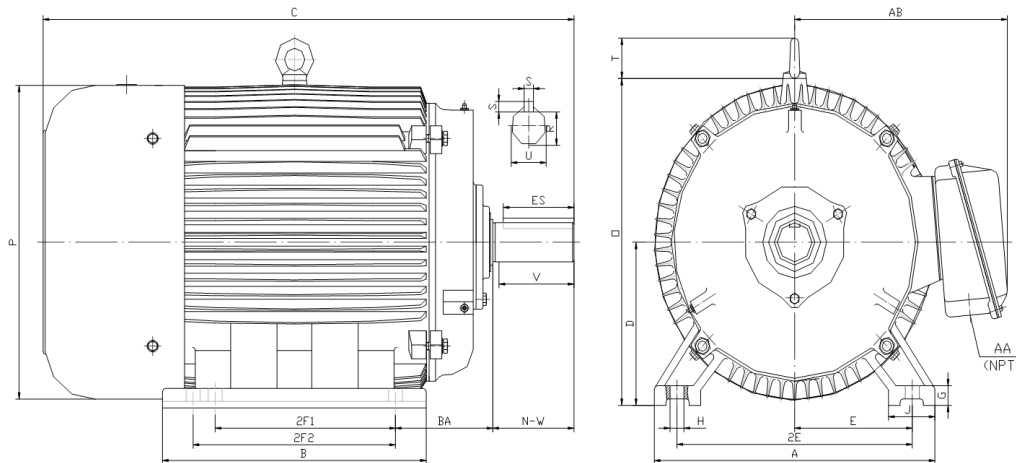

### DIMENSIONS

HP	RPM	Frame	MOUNTING														
			A	B	C	D	G	H	J	E	2E	2F1	2F2	O	P	T	BA
40	855	365T	17.10	15.40	33.50	9.00	1.15	0.66	2.95	7.00	14.00	11.25	12.25	18.10	17.60	2.60	5.88

Shaft Extension, Key Set						Conduit Box		Bearings		Mount
U	V	R	S	ES	N-W	AA	AB	DE	ODE	
2.375	5.62	2.021	0.625	4.28	5.88	3.00	14.60	6313	6313	F2

**BEARING LUBRICATION:** The bearings come lubricated with Mobil Polyrex EM Polyurea Grease. It is recommended that you add some additional lubrication when the motor is installed.

Three options (brands) for suitable lubrication include, but are not limited to, the following:

- 1.) Mobil Polyrex EM
- 2.) Citco Polyurea MP
- 3.) Conoco Phillips Polytac EP





## OWP365T-40-8

**OIL WELL PUMP MOTOR**

**HIGH TORQUE / HIGH SLIP (5 - 8%)**

**TOTALLY ENCLOSED FAN COOLED**

**INVERTER DUTY 10:1 CONSTANT TORQUE - NEMA MG1 PART 31**

Factory Certified for T2B Class I, Division II, Groups A,B,C & D and Class II, Division II, Groups F & G

### PERFORMANCE DATA

HP	RPM	Frame	Voltage	Frequency (Hz)	Full Load S.F.	Insulation Class	NEMA Design	Slip (%)	NEMA Code	Enclosure Type	IP Rating	Max. Ambient
40	855	365T	230/460/796	60	1.15	F	D	5.0	G	TEFC	55	40° C

Amps (460V)		Efficiency (%)				Power Factor			Torque (ft-lb)			DE Bearing	DE Bearing	Connection	Weight (lbs.)
FLA	LRA	100%	75%	50%	Min.	100%	75%	50%	FLT	LRT %	BDT %				
58.0	290.0	87.5	88.5	88.0	85.5	0.73	0.66	0.54	246.0	275	285	6313	6313	12 Lead 2Δ/Δ/Y	710

### NAME PLATE

<b>North American Electric, Inc. OIL WELL PUMP MOTOR</b>						<b>CONNECTION DIAGRAMS</b>		
<b>INVERTER DUTY 10:1 CONSTANT TORQUE</b>						<b>NEMA DESIGN D HIGH TORQUE/HIGH SLIP (5-8%)</b>		
CAT NO: OWP365T-40-8		HP	40	Hz	60	PHASE	3	
VOLTS	230/460/796	FLA	58.0		IP RATING	55		
RPM	855	POWER FACTOR	0.73		DESIGN	D		
FRAME	365T	NEMA NOM EFF	87.5		CODE	G		
DRIVE END BEARING	6313	NEMA MIN EFF	85.5		S.F.	1.15		
OPP DRIVE END BEARING	6313	MAX AMB	40° C		INS CLASS	F		
ENCL	TEFC	RATING	CONT	SER				
MOTOR WEIGHT	710 LBS	CONNECTION	12 Lead 2Δ/Δ/Y		LUB:	Mobil Polyrex EM		
Designed Specifically for use on Oil Well Pumping Units Hernando, Mississippi						CC 082A		
<b>230V</b> 								
<b>460V</b> 								
<b>796V</b> 								

### APPLICATIONS:

Designed Specifically for use on Oil Well Pumping Units. Suitable for use on Variable Frequency Drives (VFDs).