

APE145T-2-2

GENERAL PURPOSE ELECTRIC MOTOR

NEMA PREMIUM EFFICIENCY

TOTALLY ENCLOSED FAN COOLED

INVERTER DUTY 10:1 CT; 20:1 VT - NEMA MG1 PART 31

Factory Certified for T2B Class I, Division II, Groups A,B,C & D and Class II, Division II, Groups F & G

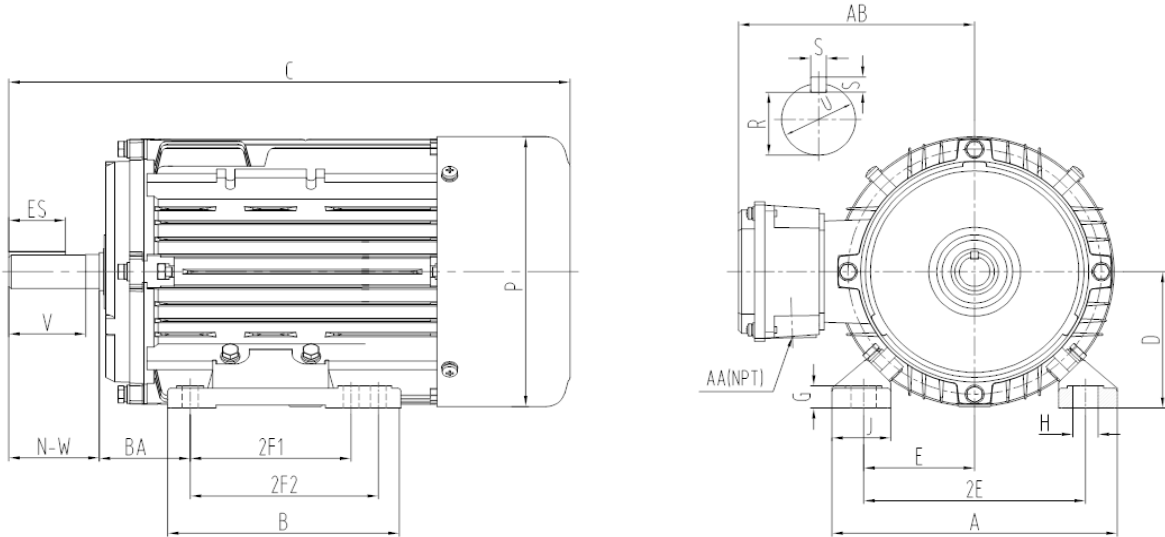

DIMENSIONS

HP	RPM	Frame	MOUNTING														
			A	B	C	D	G	H	J	E	2E	2F1	2F2	O	P	T	BA
2	3600	145T	7.00	6.20	15.10	3.50	0.57	0.39	1.46	2.75	5.50	4.90	NA	NA	5.90	NA	2.25

Shaft Extension, Key Set						Conduit Box		Bearings		Mount
U	V	R	S	ES	N-W	AA	AB	DE	ODE	
0.875	2.00	0.771	0.188	1.41	2.25	0.75	5.87	6205-ZZ	6205-ZZ	F1

BEARING LUBRICATION: The bearings come lubricated with Mobil Polyrex EM Polyurea Grease.





APE145T-2-2

GENERAL PURPOSE ELECTRIC MOTOR

NEMA PREMIUM EFFICIENCY

TOTALLY ENCLOSED FAN COOLED

INVERTER DUTY 10:1 CT; 20:1 VT - NEMA MG1 PART 31







Factory Certified for T2B Class I, Division II, Groups A,B,C & D and Class II, Division II, Groups F & G

PERFORMANCE DATA

HP	RPM	Frame	Voltage	Frequency (Hz)	Full Load S.F.	Insulation Class	NEMA Design	Slip (%)	NEMA Code	Enclosure Type	IP Rating	Max. Ambient
2	3510	145T	208-230/460	60	1.15	F	B	2.5	L	TEFC	55	40° C

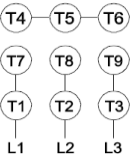
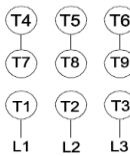
Amps (460V)		Efficiency (%)				Power Factor			Torque (ft-lb)			DE Bearing	ODE Bearing	Connection	Weight (lbs.)
FLA	LRA	100%	75%	50%	Min.	100%	75%	50%	FLT	LRT %	BDT %	6205-ZZ	6205-ZZ	9 Lead 2Y/Y	37
2.7	25	85.5	83.0	82.5	82.5	0.82	0.74	0.62	3.0	190	285				

NAME PLATE

 North American Electric, Inc.															CONNECTION DIAGRAMS 208-230V 		
INVERTER DUTY 20:1 VT; 10:1 CT																	
CAT NO: APE145T-2-2				FRAME 145T				PHASE 3				460V 					
HZ 60	S.F. 1.15	HZ 50	S.F. 1.0	ENCL TEFC	IP 55												
HP 2	RPM 3510	HP 2	RPM 2870	DUTY CONT	DES B												
VOLTS 208-230/460				VOLTS 190/380				AMB 40° C									
FLA 5.8 - 5.3 / 2.65				FLA 6.4/3.2				DE BEARING 6205-ZZ									
CODE L	P.F. 0.82	CODE F	P.F. 0.86	ODE BEARING 6205-ZZ													
EFF 85.5	MIN 82.5	EFF 83.5	MIN 80.5	LUB: Mobil Polyrex EM													
MOTOR WEIGHT 37 LBS			CONNECTION 9 Lead 2Y/Y				SER NO										
General purpose use on industrial machinery installed in damp, dusty or dirty environments. Hernando, Mississippi										   CC 082A							

APPLICATIONS:

General purpose use on pumps, fans, blowers, compressors, conveyors, material handling and other industrial machinery installed in damp, dusty or dirty environments.