

PRODUCT INFORMATION PACKET



Model No: CM38P17NZ23C

Catalog No: M1145026.00

..1/15HP..70RPM.38.TENV.115/230V.1PH.60HZ.....CM38P17NZ23C.P240...23:1.AC GEARMOTORS SUB-FHP..61LBIN.....

P240 Series



Regal and Leeson are trademarks of Regal Beloit Corporation or one of its affiliated companies.

©2018 Regal Beloit Corporation, All Rights Reserved. MC017097E





Nameplate Specifications

Output HP	0.06 Hp	Output KW	0.04 kW
Frequency	60 Hz	Voltage	115 V
Current	1.0/0.50 A	Speed	70 rpm
Service Factor	1	Phase	1
Duty	Continuous	Insulation Class	F
KVA Code	D	Frame	38
Enclosure	Totally Enclosed Non Ventilated	Overload Protector	No
Ambient Temperature	40 °C	Drive End Bearing Size	6201
Opp Drive End Bearing Size	6201	UL	Recognized
CSA	Y	CE	Y

Technical Specifications

Rotation	Reversible	Mounting	Special
Shaft Type	Parallel	Overall Length	10.46 in
Frame Length	5.13 in	Shaft Diameter	0.625 in
Shaft Extension	1.5 in		
Outline Drawing	M1030380-M1145026	Connection Diagram	M1005040.02

This is an uncontrolled document once printed or downloaded and is subject to change without notice. Date Created: 10/15/2018

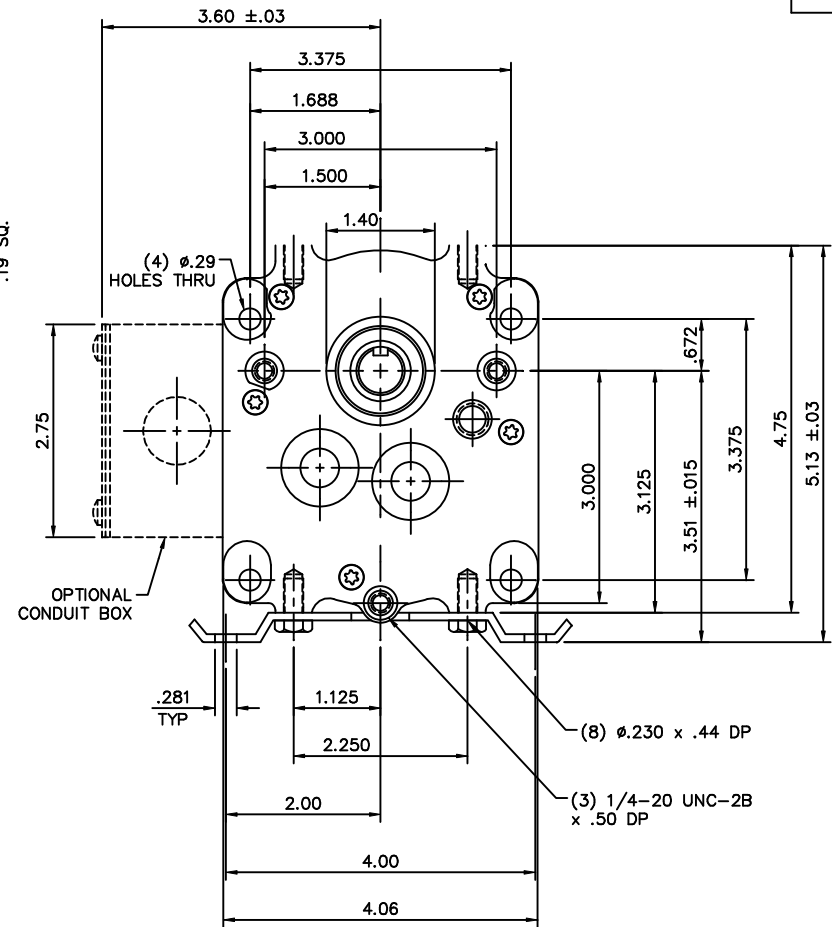
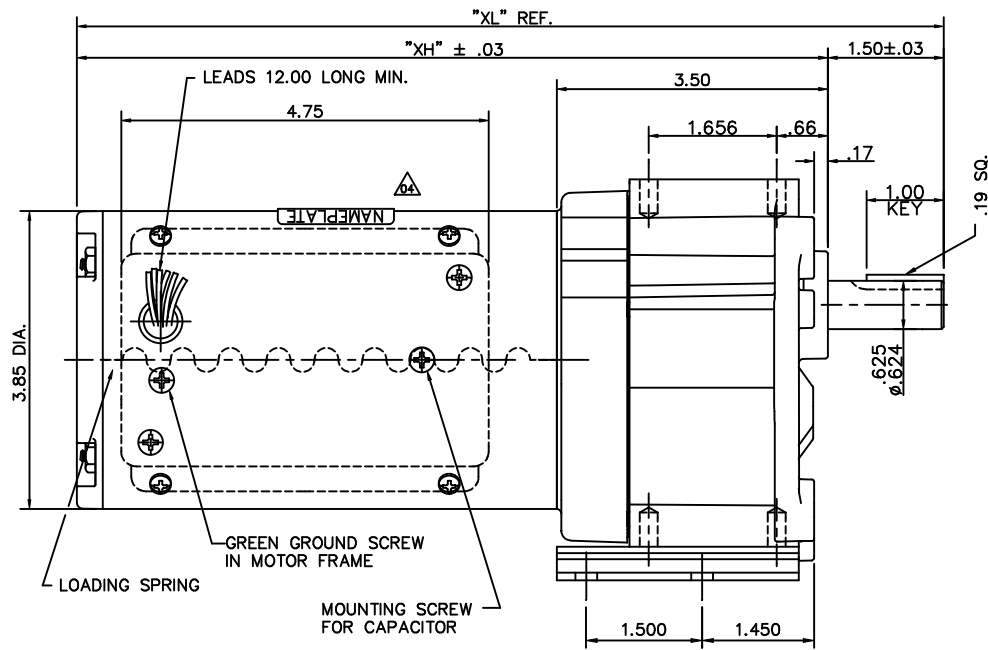

CATALOG NUMBER	OUTPUT RPM	FULL LOAD TORQUE LB.-IN.	INPUT HP	OVERHUNG LOAD LBS.	GEARMOTOR TYPE & FRAME	RATIO TO 1	"XL"	"XH"
M1145023.00	15	208	1/15	407	P243-38	114	10.46	8.96
M1145024.00	30	135	1/15	330	P242-38	52	10.46	8.96
M1145025.00	45	92	1/15	292	P242-38	35	10.46	8.96
M1145026.00	70	61	1/15	256	P242-38	23	10.46	8.96
M1145027.00	97	43	1/15	232	P242-38	16.5	10.46	8.96
M1145028.00	139	30	1/15	208	P242-38	11.5	10.46	8.96
M1145029.00	8	345	1/15	491	P243-38	216	10.46	8.96

05	EXTENDED 3 PT MOUNTING HOLES .14" TO MAKE FLUSH	RLW	6/25/02		TOLERANCES UNLESS SPECIFIED		ELECTRIC MOTORS GEARMOTORS AND DRIVES	DRAWN	SPV 05/21/94	
04	REV'D NAMEPLATE APPEARANCE FOR ASSEMBLY	BJB	6/25/02	DWF	DEC.			INCHES	CHK	
	CLARITY PER ECR 65231				.X	±.1		APPD	DWF 05/21/94	
03	3.50 WAS 3.562, 5.13 WAS 5.19		SPV 06/29/95		.XX	±.03	TITLE	SCALE	5=8	
02	ADDED CAPACITOR MOUNTING SCREW		SPV 06/29/95		.XXX	±.005	OUTLINE DRAWING	REF		
01	REVISED TO NEW STOCK STANDARDS		TMZ 05/15/95		.XXXX	±.0005	P240 GEARMOTOR - 38 FRAME A.C.	FMF	M1145023	
NO.	REVISION	BY & DATE	CHK	ANG	±1/2"	FINISH		PREV		
THIS DRAWING IN DESIGN AND DETAIL IS OUR PROPERTY AND MUST NOT BE USED EXCEPT IN CONNECTION WITH OUR WORK ALL RIGHTS OF DESIGN AND INVENTION ARE RESERVED THIS IS AN ELECTRONICALLY GENERATED DOCUMENT - DO NOT SCALE THIS PRINT						RFP	CAD FILE	M1030380	SIZE	DRAWING NO.
						DIST		B	M1030380	REV.
										05

M1005040.02

COLORED LEADS

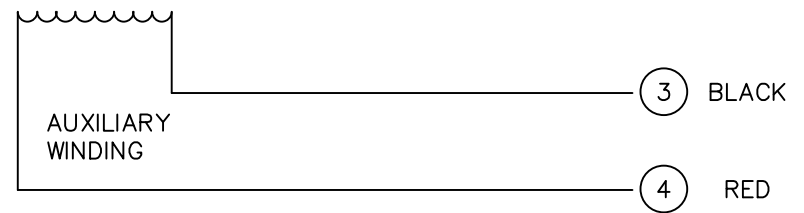
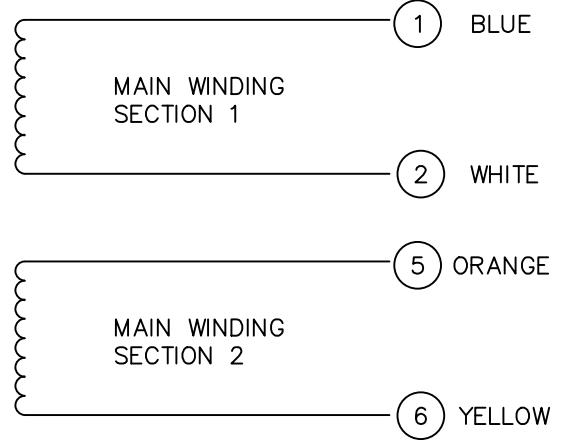
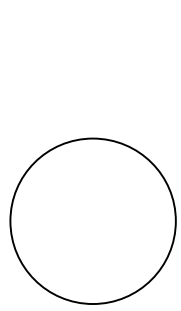

HIGH VOLTAGE CONNECTIONS

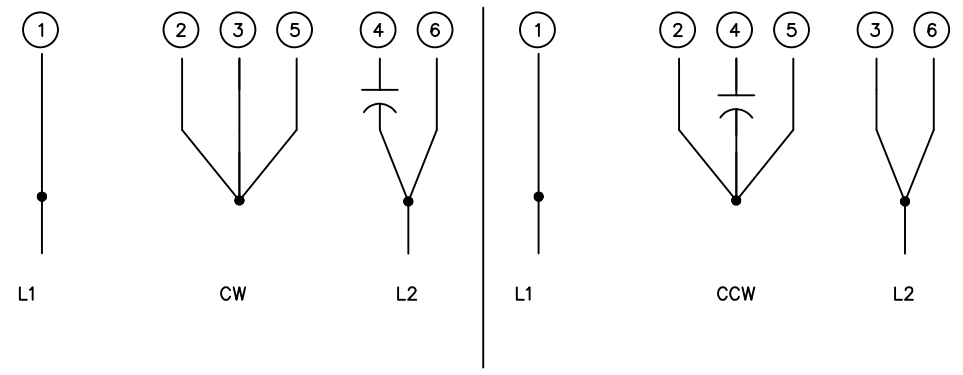

ROTATION VIEWING LEAD END OF MOTOR

LOW VOLTAGE CONNECTIONS

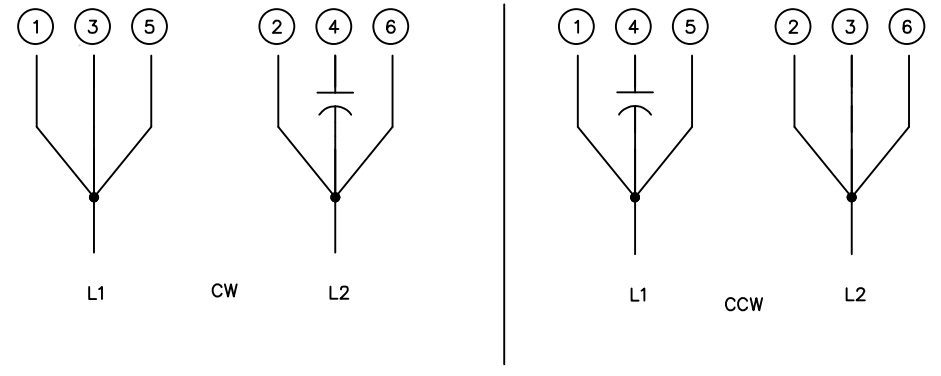

ROTATION VIEWING LEAD END OF MOTOR

				TOLERANCES UNLESS OTHERWISE SPECIFIED		LEESON ELECTRIC CORPORATION				
				DECIMALS						
				.00	± .01	DRAWN	DK	TITLE EXTERNAL WIRING DIAGRAM DUAL VOLTAGE DUAL ROTATION		
02	REDRAWN ON CAD	AJR	6/28/99	.000	± .005	CH'K'D.	10/3/91			
01	REMOVED CAP FROM LEFT DIAGRAM	DD	9/16/95	.0000	± .0005	APPR.	10/3/91	MAT'L.		
NO.	REVISION	BY	DATE	FRACTIONS	± 1/64	SCALE	NONE			
THIS DRAWING IN DESIGN AND DETAIL IS OUR PROPERTY AND MUST NOT BE USED EXCEPT IN CONNECTION WITH OUR WORK ALL RIGHTS OF DESIGN AND INVENTION ARE RESERVED				ANGLES	± 1/2°	REF.		FINISH	SIZE	DRAWING NO.
				INCH/MM		FMF	PR91376	LECO CORP.	A	M1005040.02