

PRODUCT INFORMATION PACKET



Model No: 985.505E
Catalog No: M1115019.00
...40:1.62RPM.19LBIN.1/17HP.25...DC GEARMOTORS SUB-FHP.90V..TENV.985.505E
Right Angle



Regal and Leeson are trademarks of Regal Beloit Corporation or one of its affiliated companies.
©2018 Regal Beloit Corporation, All Rights Reserved. MC017097E





Nameplate Specifications

Output HP	0.06 Hp	Output KW	0.04 kW
Voltage	90 V	Current	0.87 A
Speed	62 rpm	Service Factor	1
Efficiency	20.6 %	Duty	Continuous
Insulation Class	H	Frame	25
Enclosure	Totally Enclosed Non Ventilated	Overload Protector	No
Ambient Temperature	40 °C	Drive End Bearing Size	608
Opp Drive End Bearing Size	608	UL	Recognized
CSA	Y	CE	Y

Technical Specifications

Rotation	Reversible	Mounting	Special
Shaft Type	Right Angle	Overall Length	8.80 in
Frame Length	4.25 in	Shaft Diameter	0.500 in
Shaft Extension	1.3 in		
Outline Drawing	M1030885-M1115019	Connection Diagram	M100526001

This is an uncontrolled document once printed or downloaded and is subject to change without notice. Date Created: 10/15/2018

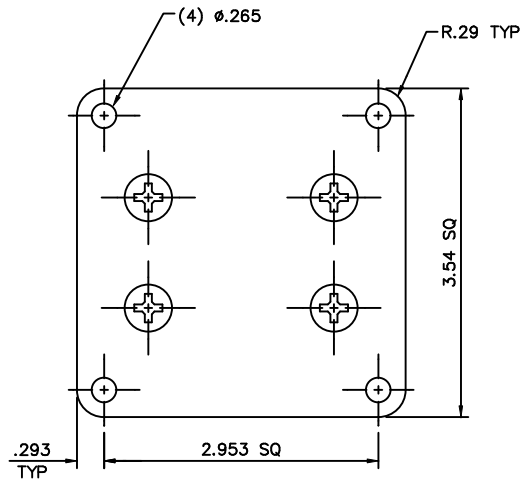
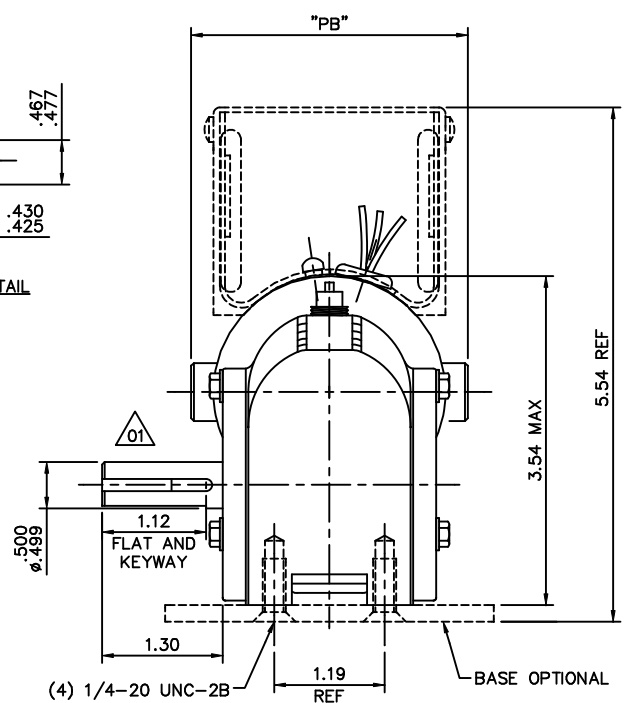
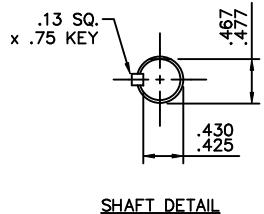
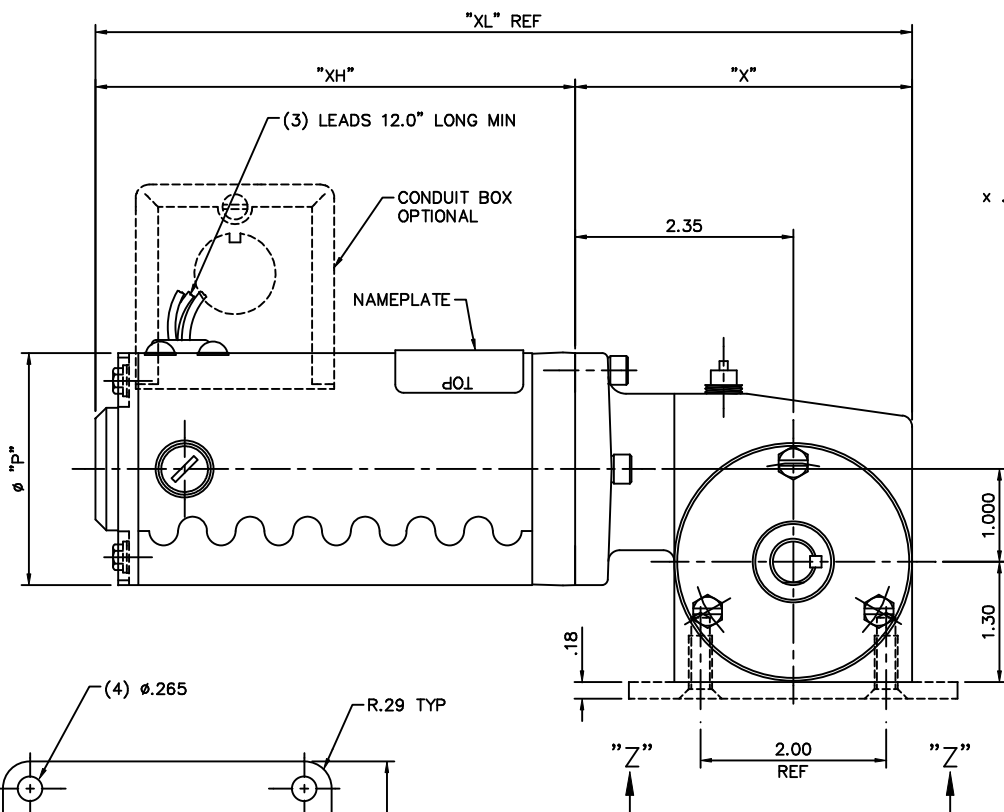

CATALOG NUMBER	SPEED RANGE RPM	FULL LOAD TORQUE LB.-IN.	INPUT HP	OVERHUNG LOAD LBS.	RATIO TO 1	"P"	"PB"	"X"	"XH"	"XL"
M1115018.00	42-7	22	1/17	185	60	2.50	2.98	3.63	5.17	8.80
M1115019.00	62-1	19	1/17	185	40	2.50	2.98	3.63	5.17	8.80
M1115020.00	125-2.1	16	1/17	185	20	2.50	2.98	3.63	5.17	8.80
M1115021.00	250-4	10	1/17	185	10	2.50	2.98	3.63	5.17	8.80
M1115022.00	500-8	5.2	1/17	185	5	2.50	2.98	3.63	5.17	8.80

		TOLERANCES UNLESS SPECIFIED		LEESON	ELECTRIC MOTORS GEARMOTORS AND DRIVES	DRAWN	IPG 7/1/03		
		DEC. INCHES				CHK	SAD 7/1/03		
		.X ±.1				APPD			
03	.03 TOL. ADDED TO LETTER COLUMNS, ECR 88023	VS 6/15/05	BC .XX ±.03	TITLE		SCALE	3=4		
02	GEAR BOX WAS M1550166.XXX/ECO 05-1201 EFF.7/5/05	RPB 5/18/05	BC .XXX ±.005	25 FRAME DC - RIGHT ANGLE GEARBOX		REF	PR020634.01		
01	FIXED OUTPUT SHAFT VIEW, ECR 82288	IPG 3/22/04	SAD .XXXX ±.0005	MAT'L		FMF	M1115019.00		
NO.	REVISION	BY & DATE	CHK ANG ±1/2"	FINISH		PREV			
THIS DRAWING IN DESIGN AND DETAIL IS OUR PROPERTY AND MUST NOT BE USED EXCEPT IN CONNECTION WITH OUR WORK ALL RIGHTS OF DESIGN AND INVENTION ARE RESERVED THIS IS AN ELECTRONICALLY GENERATED DOCUMENT - DO NOT SCALE THIS PRINT				RFP	CAD FILE	M1030885	SIZE	DRAWING NO.	REV.
				DIST			B	M1030885.00	03

ERROR: syntaxerror
OFFENDING COMMAND: --nostringval--

STACK:

131 /quotesinglbase
130 /bar
124 /grave
96 /quotesingle
39 /dotlessi
13 /caron
12 /ogonek
11 /hungarumlaut
10 /cedilla
9 /ring
8 /dieresis
7 /dotaccent
6 /breve
5 /macron
4 /tilde
3 /circumflex
2 /acute
1 /grave
0 -mark-
/ANSIvec
-dictionary-
/Pscript_WinNT_Compat
-dictionary-

D.C. MOTORS

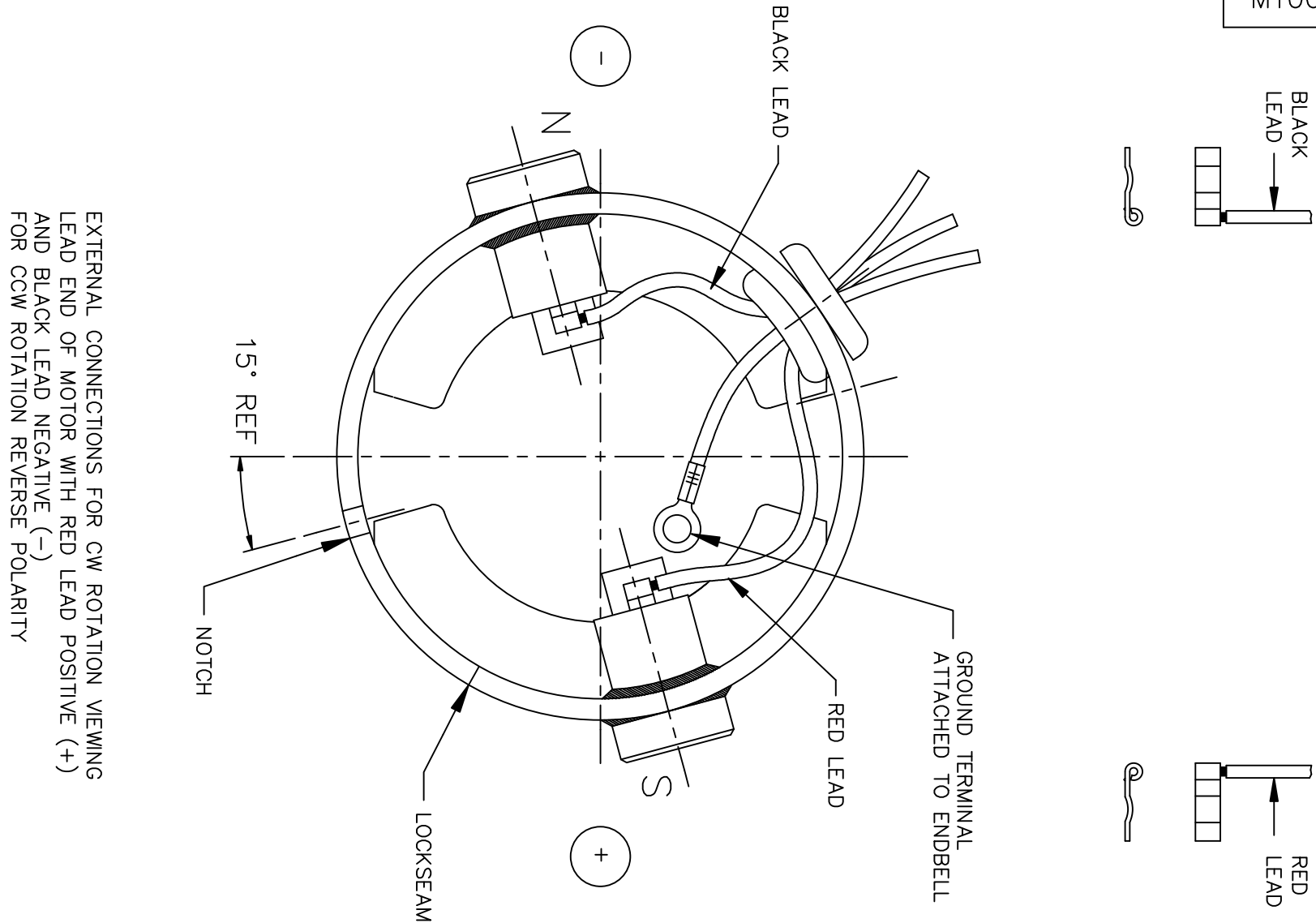

EXTERNAL CONNECTIONS FOR CW ROTATION VIEWING
LEAD END OF MOTOR WITH RED LEAD POSITIVE (+)
AND BLACK LEAD NEGATIVE (-)
FOR CCW ROTATION REVERSE POLARITY

05	SWITCH LEADS TO MATCH ROTATION, ISAAC 10-1990	IPG 5/17/2010	SK	TOLERANCES UNLESS SPECIFIED		 ELECTRIC MOTORS GEARMOTORS AND DRIVES	DRAWN IPG 6/4/03	
04	SWITCH "N" AND "S" TO MATCH FRAME/MAGNET ASSY	IPG 4/26/2010	SK	DEC.	INCHES		CHK SAD 6/4/03	
	DRAWING, ISAAC 10-1709			.X	±.1		APPD	
03	ADDED "TRU-TORQ" TO THE TITLE BLOCK AND ORACLE	IPG 3/2/2004	SAD	.XX	±.03	TITLE CONNECTION DIAGRAM	SCALE 1=1	
	DESCRIPTION, ECR 83990			.XXX	±.005		REF PR020634.01	
02	SWITCHED N & S PER ECR 83629	BPW 12/19/03	SAD	.XXXX	±.0005	MAT'L.	FMF M1115050.00	
NO.	REVISION	BY & DATE	CHK	ANG	±1/2'	FINISH	PREV	
THIS DRAWING IN DESIGN AND DETAIL IS OUR PROPERTY AND MUST NOT BE USED EXCEPT IN CONNECTION WITH OUR WORK ALL RIGHTS OF DESIGN AND INVENTION ARE RESERVED THIS IS AN ELECTRONICALLY GENERATED DOCUMENT - DO NOT SCALE THIS PRINT			RFP	CAD FILE M100526001		SIZE A	DRAWING NO. M1005260.01	REV. 05
			DIST					