

PRODUCT INFORMATION PACKET



Model No: C80T11FZ6C

Catalog No: 192049.00

3/4HP-

.55KW..1130/910RPM.80.IP55.230/460V.3PH.60/50HZ.CONT.40C.1.15/1.15SF.B3/B14.C80T11FZ6C.....IEC

Metric.NOT.....

TEFC



Regal and Leeson are trademarks of Regal Beloit Corporation or one of its affiliated companies.

©2018 Regal Beloit Corporation, All Rights Reserved. MC017097E



Product Information Packet: Model No: C80T11FZ6C, Catalog No:192049.00 3/4HP-.55KW..1130/910RPM.80.IP55.230/460V.3PH.60/50HZ.CONT.40C.1.15/1.15SF.B3/B14.C80T11FZ6C.....IEC Metric.NOT.....



Nameplate Specifications

Output HP	0.75 Hp	Output KW	0.56 kW
Frequency	60 Hz	Voltage	230/460 V
Current	2.7/1.4 A	Speed	1130 rpm
Service Factor	1.15	Phase	3
Efficiency	72 %	Duty	Continuous
Insulation Class	F	Design Code	B
KVA Code	H	Frame	D80C
Enclosure	Totally Enclosed Fan Cooled	Overload Protector	No
Ambient Temperature	40 °C	Drive End Bearing Size	6204
Opp Drive End Bearing Size	6204	UL	Recognized
CSA	Y	CE	Y
IP Code	55		

Technical Specifications

Electrical Type	Squirrel Cage Inverter Rated	Starting Method	Line Or Inverter
Poles	6	Rotation	Reversible
Mounting	B3	Motor Orientation	HORIZONTAL
Drive End Bearing	BALL	Opp Drive End Bearing	BALL
Frame Material	Aluminum	Shaft Type	IEC
Overall Length	11.10 in	Frame Length	5.31 in
Shaft Diameter	0.750 in	Shaft Extension	1.57 in
Assembly/Box Mounting	F3		
Outline Drawing	16986500	Connection Diagram	005465.01

This is an uncontrolled document once printed or downloaded and is subject to change without notice. Date Created: 10/15/2018

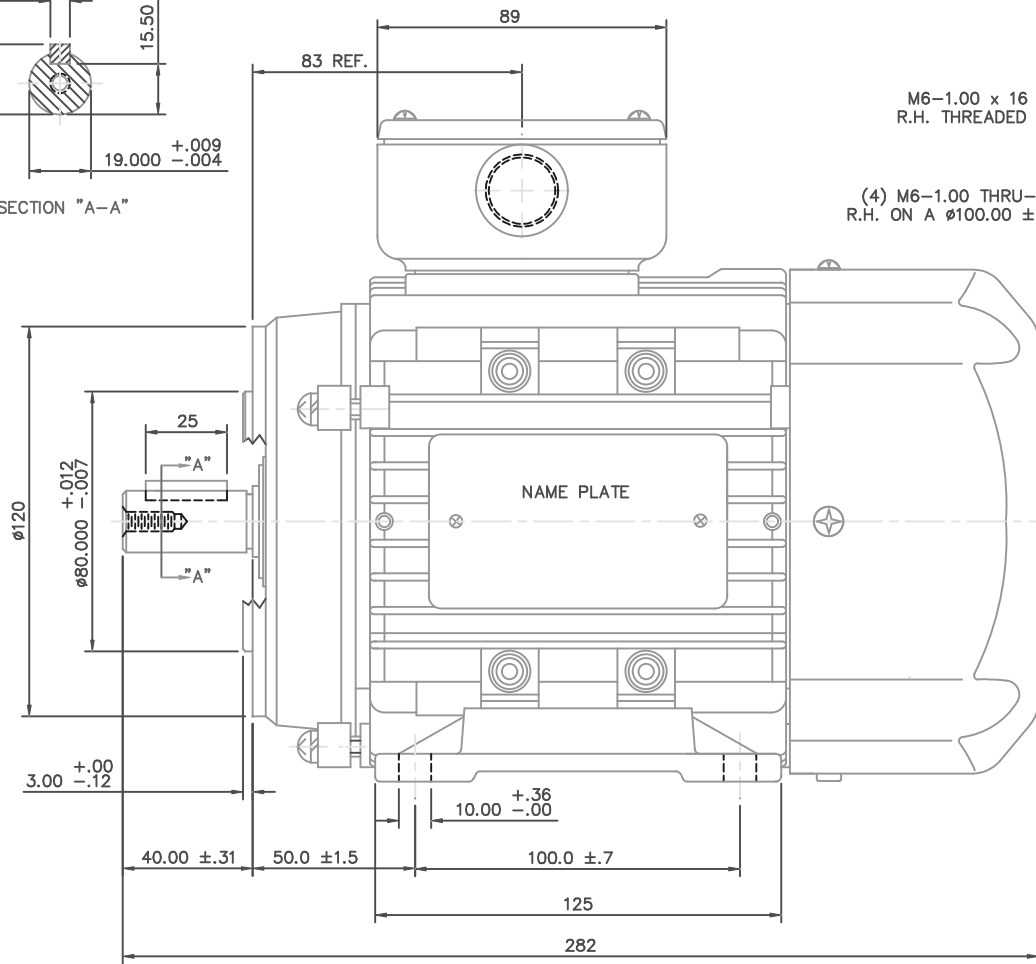
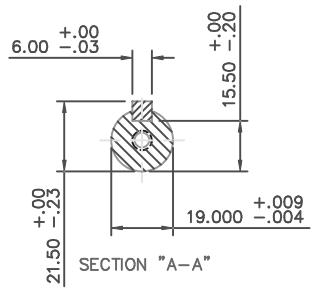

M6-1.00 x 16 DEEP R.H. THREADED SHAFT
 (4) M6-1.00 THRU-THREAD R.H. ON A Ø100.00 ±.17 B.C.

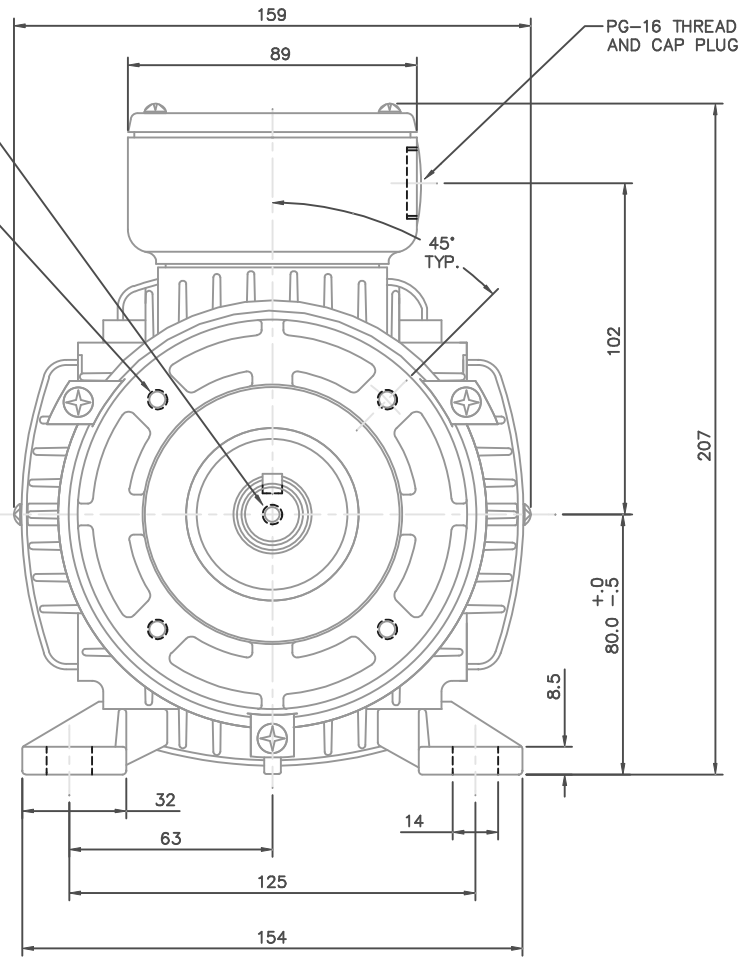

		TOLERANCES UNLESS SPECIFIED		 ELECTRIC MOTORS GEARMOTORS AND DRIVES	DRAWN ADS 01/30/02
		DEC.	INCHES		CHK
		.X	±.1		APPD
		.XX	±.03		SCALE 1=1.5
		.XXX	±.005		REF OSVC-300-560
		.XXXX	±.0005	MAT'L ALUMINUM	FMF LEESON STOCK
NO.	REVISION	BY & DATE	CHK ANG ±1/2'	FINISH	PREV
THIS DRAWING IN DESIGN AND DETAIL IS OUR PROPERTY AND MUST NOT BE USED EXCEPT IN CONNECTION WITH OUR WORK. ALL RIGHTS OF DESIGN AND INVENTION ARE RESERVED. THIS IS AN ELECTRONICALLY GENERATED DOCUMENT - DO NOT SCALE THIS PRINT				RFP CAD FILE 16986500	SIZE B
				DRAWING NO. 169865-00	REV.

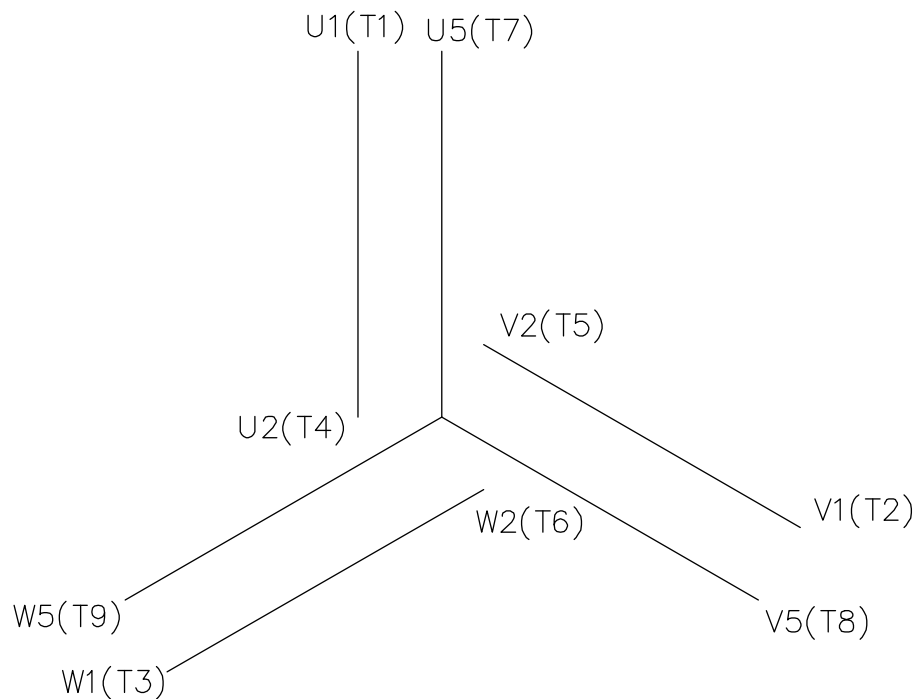

REF. DECAL (IEC) 080644
REF. DECAL (NEMA) 080446

IEC MARKINGS

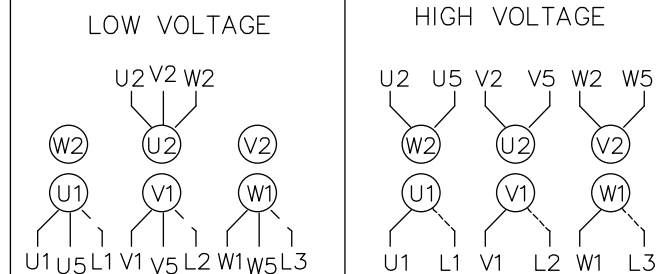

LINE VOLTAGE	L1	L2	L3	JOIN		
TERMINAL	U1	V1	W1	W2	U2	V2
LOW	U1,U5	V1,V5	W1,W5	---	U2,V2,W2	---
HIGH	U1	V1	W1	U2,U5	V2,V5	W2,W5

NEMA MARKINGS

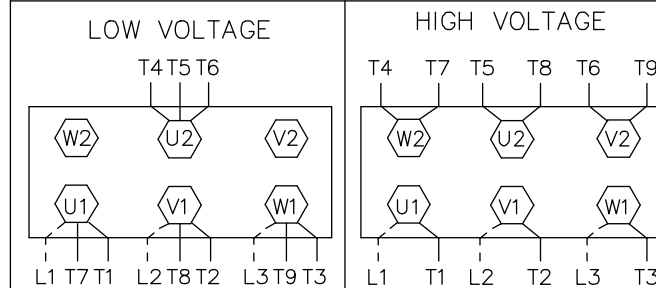

LINE VOLTAGE	L1	L2	L3	JOIN		
TERMINAL	U1	V1	W1	W2	U2	V2
LOW	T1, T7	T2, T8	T3, T9	---	T4,T5,T6	---
HIGH	T1	T2	T3	T4, T7	T5, T8	T6, T9

		TOLERANCES UNLESS SPECIFIED		 ELECTRIC MOTORS GEARMOTORS AND DRIVES	DRAWN				
		DEC.	INCHES		MGM 12/3/02				
		.X	±.1		CHK				
		.XX	±.01		APPD				
		.XXX	±.005		SCALE 1=1				
01	NEMA LV CONNECTION WAS INCORRECT	RLW	8/4/03	.XXXX	±.0005	TITLE	EXTERNAL WIRING DIAGRAM	REF	00537703
NO.	REVISION	BY & DATE	CHK	ANG	±1/2'	MAT'L.	IEC/NEMA MARKINGS	FMF	
			RFP	CAD FILE		00546501	SIZE	DRAWING NO.	REV.
			DIST				A	005465-01	01

THIS DRAWING IN DESIGN AND DETAIL IS OUR PROPERTY AND MUST NOT BE USED EXCEPT IN CONNECTION WITH OUR WORK ALL RIGHTS OF DESIGN AND INVENTION ARE RESERVED THIS IS AN ELECTRONICALLY GENERATED DOCUMENT - DO NOT SCALE THIS PRINT



LEESON ELECTRIC CORPORATION
TYPICAL PERFORMANCE CURVE for AC MOTOR

Model No 192049.00

Catalog No 192049.00

Curve at 460 Volts HP 0.75&0.75 PHASE 3
60 HZ
0.75 HP VOLTS 230/460&200/400

HZ 60&50 RPM 1130&910

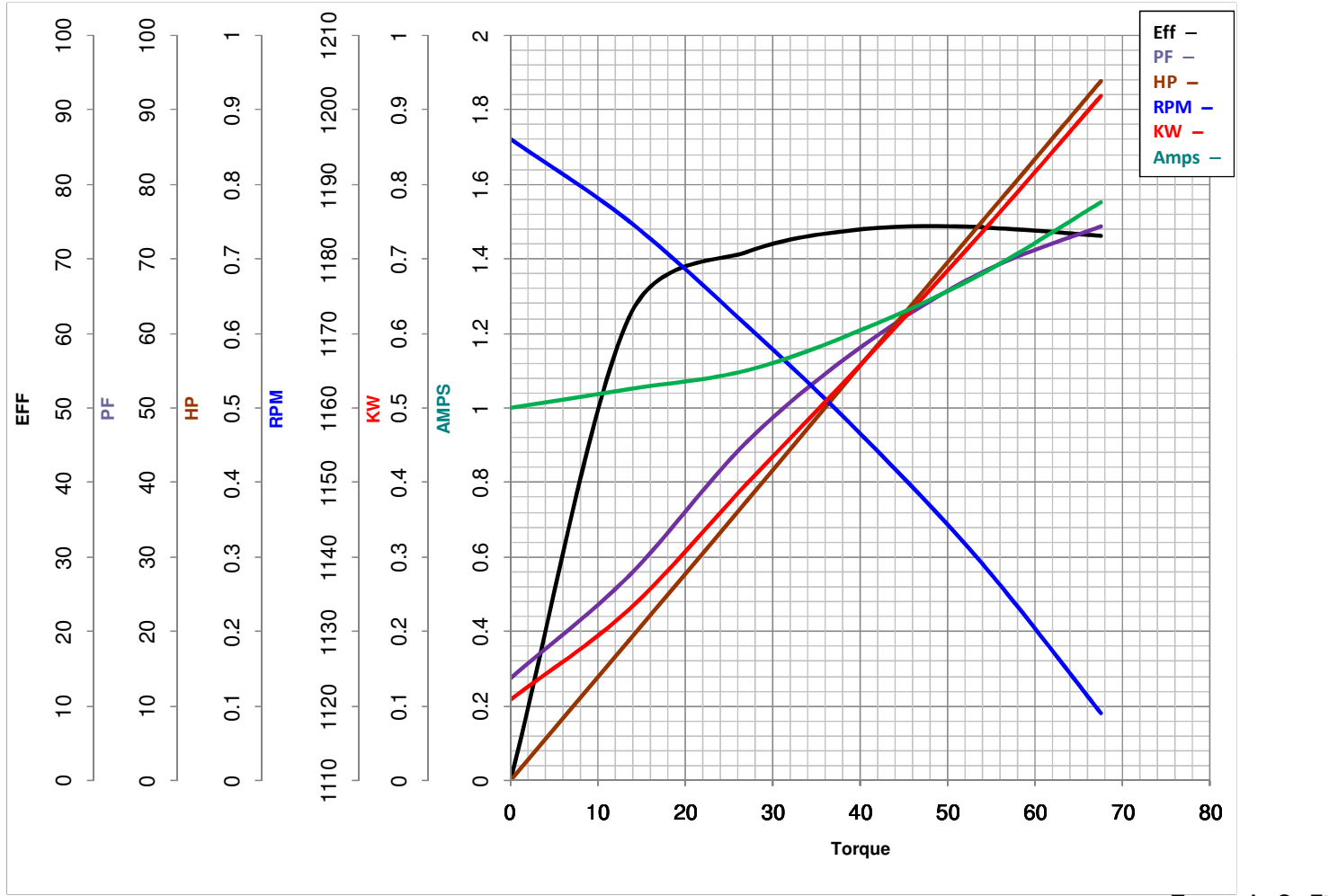

FL TORQUE	<u>54</u> Oz.Ft	FL AMPS	<u>2.7/1.35</u>
BD TORQUE	<u>150.0</u> Oz.Ft	PU TORQUE	<u>104.0</u> Oz.Ft
LR TORQUE	<u>115</u> Oz.Ft	LR AMPS	<u>6.2</u>
WINDING	QT8063-3	Date	5/23/2018