

PRODUCT INFORMATION PACKET



Model No: C80T17FZ3C

Catalog No: 192048.00

3/4HP-

.55KW..1690/1390RPM.80.IP55.230/460V.3PH.60/50HZ.CONT.40C.1.15/1.15SF.B3/B14.C80T17FZ3C.....IE

C METRIC.NOT.....

TEFC



Regal and Leeson are trademarks of Regal Beloit Corporation or one of its affiliated companies.

©2018 Regal Beloit Corporation, All Rights Reserved. MC017097E



Product Information Packet: Model No: C80T17FZ3C, Catalog No:192048.00 3/4HP-.55KW..1690/1390RPM.80.IP55.230/460V.3PH.60/50HZ.CONT.40C.1.15/1.15SF.B3/B14.C80T17FZ3C.....IEC METRIC.NOT.....



Nameplate Specifications

Output HP	0.75 Hp	Output KW	0.56 kW
Frequency	60 Hz	Voltage	230/460 V
Current	2.5/1.3 A	Speed	1690 rpm
Service Factor	1.15	Phase	3
Efficiency	74 %	Duty	Continuous
Insulation Class	F	Design Code	B
KVA Code	H	Frame	D80C
Enclosure	Totally Enclosed Fan Cooled	Overload Protector	No
Ambient Temperature	40 °C	Drive End Bearing Size	6204
Opp Drive End Bearing Size	6204	UL	Recognized
CSA	Y	CE	Y
IP Code	55		

Technical Specifications

Electrical Type	Squirrel Cage Inverter Rated	Starting Method	Line Or Inverter
Poles	4	Rotation	Reversible
Mounting	B3	Motor Orientation	HORIZONTAL
Drive End Bearing	BALL	Opp Drive End Bearing	BALL
Frame Material	Aluminum	Shaft Type	IEC
Overall Length	11.10 in	Frame Length	5.31 in
Shaft Diameter	0.750 in	Shaft Extension	1.57 in
Assembly/Box Mounting	F3		
Outline Drawing	16986500	Connection Diagram	005465.01

This is an uncontrolled document once printed or downloaded and is subject to change without notice. Date Created: 10/15/2018

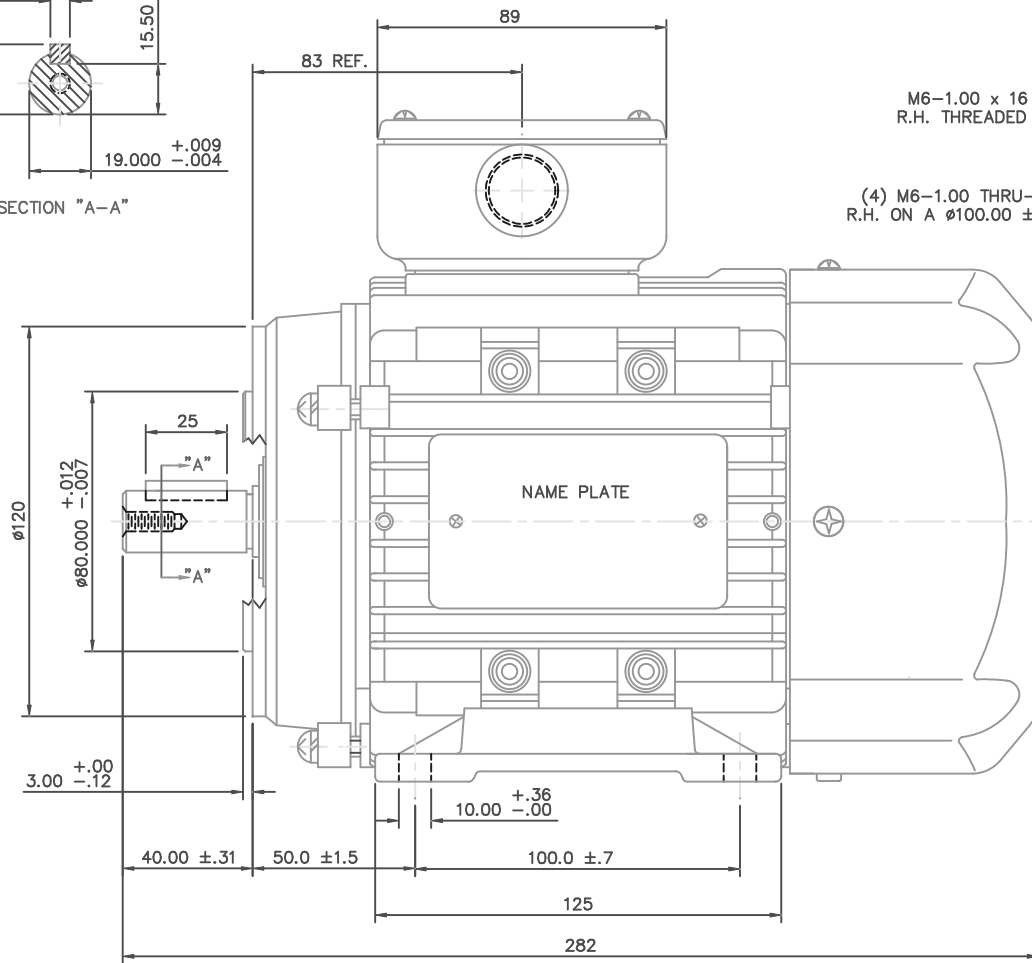
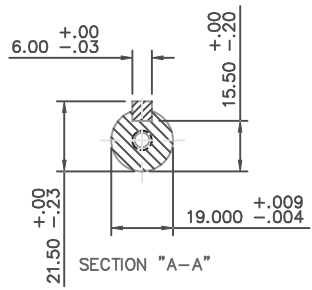

M6-1.00 x 16 DEEP R.H. THREADED SHAFT
 (4) M6-1.00 THRU-THREAD R.H. ON A Ø100.00 ±.17 B.C.

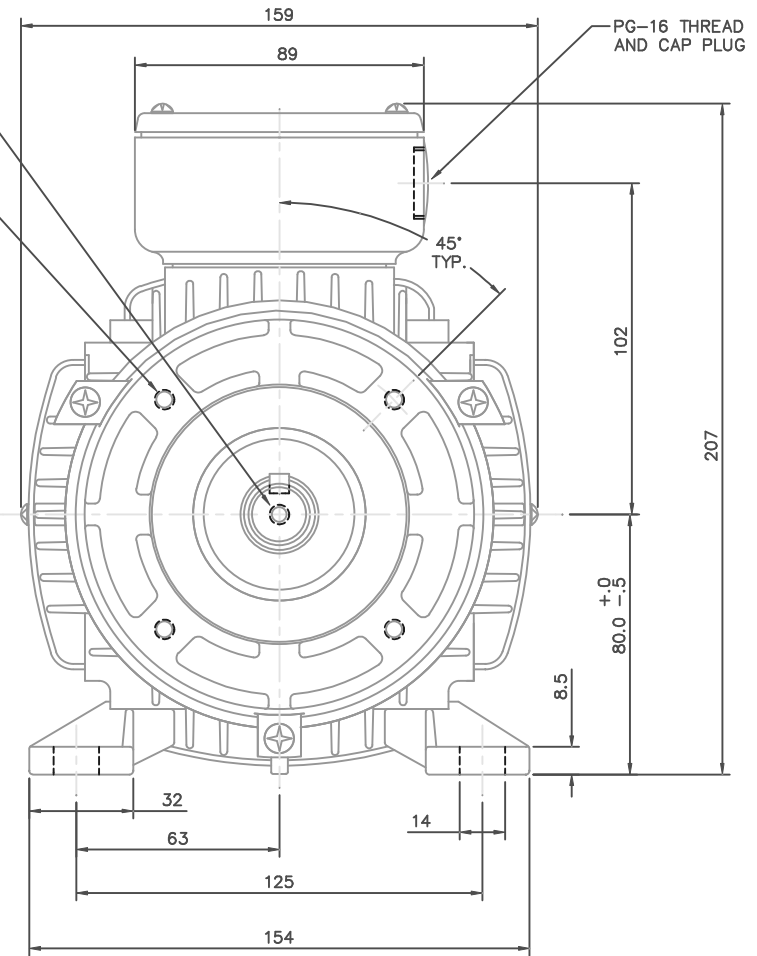

NO.		REVISION	BY & DATE	CHK	ANG	±1/2"	FINISH	LEESON ELECTRIC MOTORS GEARMOTORS AND DRIVES		DRAWN	ADS 01/30/02	
TO TOLERANCES UNLESS SPECIFIED							DEC.	INCHES	TITLE			SCALE
.X							±.1	METRIC OUTLINE, IMB34			1=1.5	
.XX							±.03	IEC-80 FRAME TEFC RIGID W/B14 FLANGE			REF	OSVC-300-560
.XXX							±.005	ALUMINUM			FMF	LEESON STOCK
.XXXX							±.0005				PREV	
THIS DRAWING IN DESIGN AND DETAIL IS OUR PROPERTY AND MUST NOT BE USED EXCEPT IN CONNECTION WITH OUR WORK ALL RIGHTS OF DESIGN AND INVENTION ARE RESERVED THIS IS AN ELECTRONICALLY GENERATED DOCUMENT - DO NOT SCALE THIS PRINT				RFP	CAD FILE	16986500	SIZE	DRAWING NO.		B	169865-00	
				DIST					REV.			

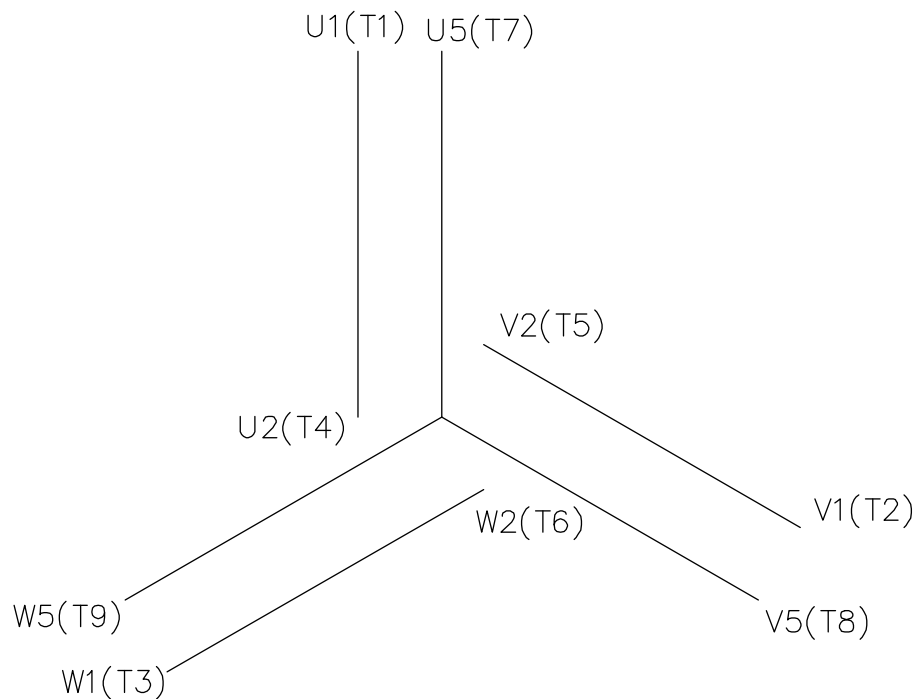

REF. DECAL (IEC) 080644
REF. DECAL (NEMA) 080446

IEC MARKINGS

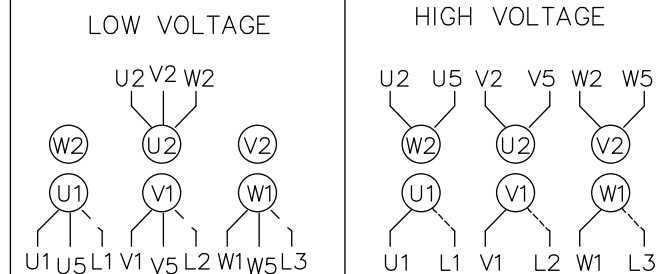

LINE VOLTAGE	L1	L2	L3	JOIN		
TERMINAL	U1	V1	W1	W2	U2	V2
LOW	U1,U5	V1,V5	W1,W5	---	U2,V2,W2	---
HIGH	U1	V1	W1	U2,U5	V2,V5	W2,W5

NEMA MARKINGS

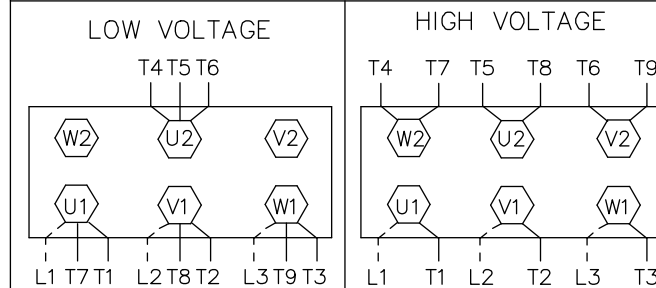

LINE VOLTAGE	L1	L2	L3	JOIN		
TERMINAL	U1	V1	W1	W2	U2	V2
LOW	T1, T7	T2, T8	T3, T9	---	T4,T5,T6	---
HIGH	T1	T2	T3	T4, T7	T5, T8	T6, T9

		TOLERANCES UNLESS SPECIFIED		 ELECTRIC MOTORS GEARMOTORS AND DRIVES	DRAWN		
		DEC.	INCHES		MGM 12/3/02		
		.X	±.1		CHK		
		.XX	±.01		APPD		
		.XXX	±.005		SCALE 1=1		
01	NEMA LV CONNECTION WAS INCORRECT	RLW	8/4/03	.XXXX	±.0005	TITLE EXTERNAL WIRING DIAGRAM 3 PHASE - DUAL VOLTAGE - W/TERM BLOCK	REF 00537703
NO.	REVISION	BY & DATE	CHK	ANG	±1/2'	MAT'L. IEC/NEMA MARKINGS	FMF
			RFP	CAD FILE 00546501		FINISH THERMAL TRANSFER	PREV
THIS DRAWING IN DESIGN AND DETAIL IS OUR PROPERTY AND MUST NOT BE USED EXCEPT IN CONNECTION WITH OUR WORK ALL RIGHTS OF DESIGN AND INVENTION ARE RESERVED THIS IS AN ELECTRONICALLY GENERATED DOCUMENT - DO NOT SCALE THIS PRINT			DIST		SIZE A	DRAWING NO. 005465-01	REV. 01



LEESON ELECTRIC CORPORATION
 TYPICAL PERFORMANCE CURVE for AC MOTOR

Model No 192048.00

Catalog No 192048.00

Curve at 460 Volts HP 0.75&0.75 PHASE 3
60 HZ
0.75 HP VOLTS 230/460&200/400

HZ 60&50 RPM 1690&1390

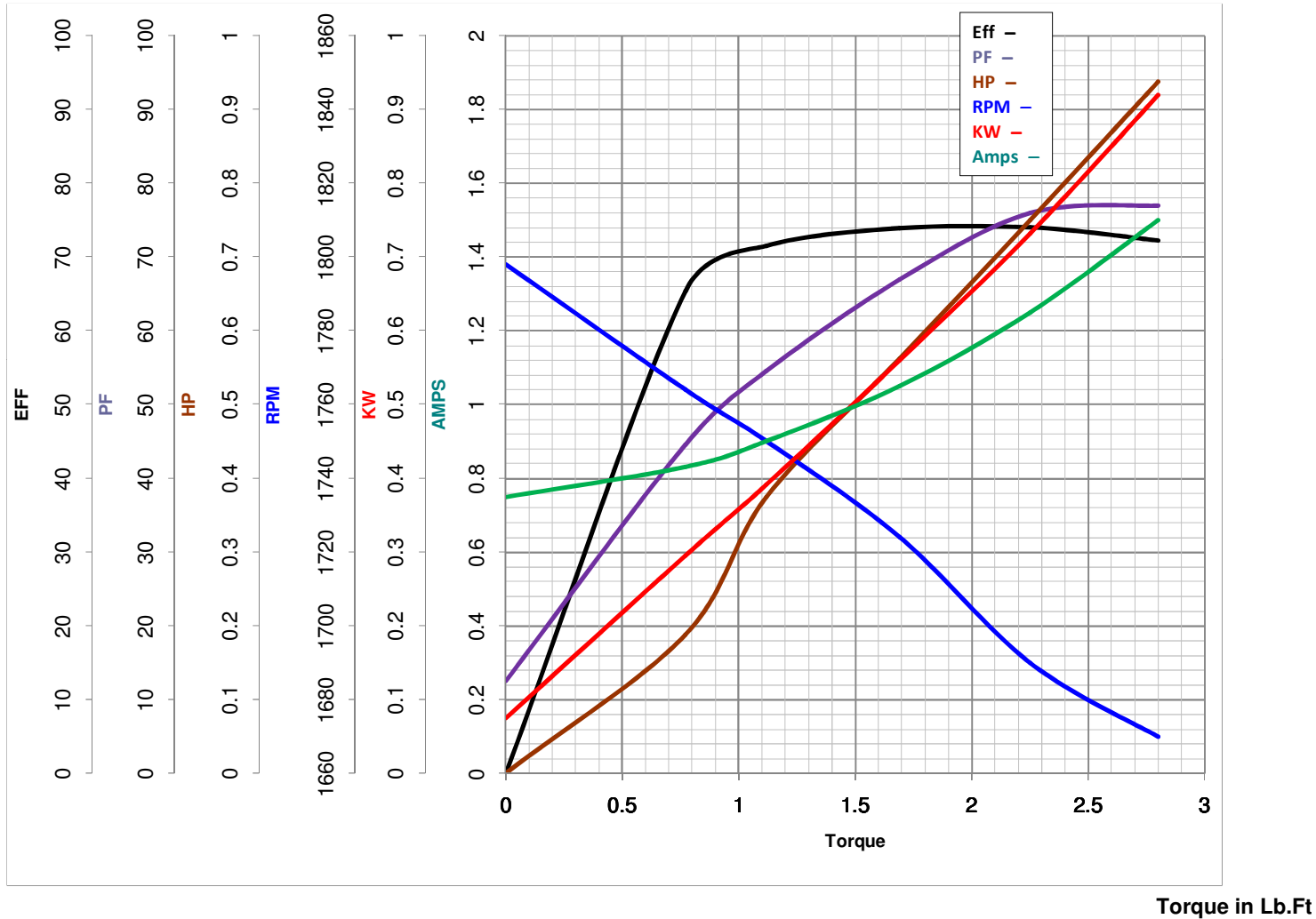

FL TORQUE 2.25 Lb.Ft
 BD TORQUE 6.1 Lb.Ft
 LR TORQUE 5.85 Lb.Ft

FL AMPS 2.5/1.25
 PU TORQUE 5.4 Lb.Ft
 LR AMPS 6.8

WINDING QT8041-3

Date 5/22/2018